

VERTEX LASER GEO/ LASER GEO

USER GUIDE 1.0

PRODUCT NUMBER 1003



Vertex Laser Geo

LASER AND ULTRASOUND



Laser Geo

LASER

User Guide – English

CONTENTS

OVERVIEW	4	HEIGHT DME – 2-POINT MEASURING WITH MANUAL DISTANCE	18
HAGLÖF SWEDEN®	4	SEILKRANPRO (MAP TRAIL)	19
VERTEX LASER GEO AND LASER GEO	4	DISTANCE WITH DME OR LASER	20
<i>Features</i>	4	SEILKRANPRO STEP BY STEP	20
INSTRUMENT OVERVIEW	6	<i>Trail Length</i>	22
TRANSPONDER T3.....	7	<i>Trail CSV Data</i>	22
360 ADAPTER/SPREADER.....	7	<i>Example Google Earth file, KML file</i>	22
MONOPOD PLOT CENTER STAFF	7	MAP TARGET	23
MONOPOD	7	MAP TARGET STEP BY STEP	23
FUNCTIONS AND USE OF THE BUTTONS	8	<i>DME BASELINE</i>	25
BUTTONS.....	8	<i>TARGET SUMMARY</i>	25
<i>ON</i>	8	<i>TARGET CSV Data</i>	25
<i>ARROW BUTTONS</i>	8	<i>Example Google Earth file, KML file</i>	26
<i>DME button</i>	8	TO EVALUATE MAP TARGET DATA	26
<i>SEND button</i>	8	MAP GPS	27
<i>EXIT (DME + SEND)</i>	8	<i>TARGET CSV DATA</i>	27
<i>Reset</i>	8	<i>EXAMPLE GOOGLE EARTH FILE, KML FILE</i>	28
<i>Turn off</i>	8	COMPASS	29
SIGHT.....	9	COMPASS FUNCTION IN THE GEO INSTRUMENT.....	29
<i>Red Dot Sight</i>	9	<i>Using the Compass</i>	29
<i>Heads-up Display</i>	9	3D VECTOR	30
BATTERY AND CHARGING OF BATTERY	9	ANGLE– MEASURING OF ANGLES/INCLINATION	32
MAIN SCREEN	9	ANGLE – HORIZONTAL DISTANCE WITH ULTRASOUND WITH THE VERTEX LASER GEO.....	32
<i>Status Icons</i>	9	LINE CLEAR	33
MENU SCHEME	10	POWER LINE EXAMPLE	33
SETTINGS	11	<i>STEP1</i>	33
METRIC/FEET:.....	11	<i>STEP 2: 3-POINT MEASURING WITH LASER</i>	33
DEG/GRAD/%:	11	<i>STEP 2: 2-POINT MEASURING WITH ULTRASOUND IN THE VERTEX LASER GEO</i>	34
P.OFFSET:	11	MIN. DIST.....	35
TRP.HGT:	11	<i>STEP1 – First point on the powerline</i>	35
EYE HGT:.....	12	<i>STEP2 – Second point on the powerline</i>	35
M.DIST:.....	12	<i>STEP3 – Third point on the object</i>	36
LASER MODE:	12	<i>Result</i>	36
BAF:	12	DELTA HGT	37
AZIMUTH	12	DELTA HEIGHT FUNCTION	37
MAGNETIC DECLINATION:.....	13	DME – DISTANCE MEASURING WITH ULTRASOUND VERTEX LASER GEO	39
DISTANCE MEASURING	14	CALIBRATE – CALIBRATING THE ULTRASOUND	39
DISTANCE MEASURING METHODS.....	14	BAF – BASAL AREA FUNCTION	40
<i>Laser</i>	14	<i>BAF with Laser</i>	40
<i>Ultrasound</i>	14	GPS	41
HEIGHTS	15	GPS USE.....	41
HEIGHT 3P – 3-POINT MEASURING WITH LASER	15		
HEIGHT 1PL – 1-POINT MEASURING WITH LASER.....	16		
HEIGHT DME – 2-POINT MEASURING WITH ULTRASOUND	17		

<i>Turn on the GPS</i>	41
<i>USE AS EXTERNAL GPS</i>	42
<i>GPS fix</i>	42
<i>Store a Single Coordinate</i>	43
USE GPS TO MEASURE AREA.....	44
<i>GPS DATA</i>	44
EXAMPLES OF GOOGLE EARTH FILE, (KML FILE)	45
CONTRAST – SETTINGS OF DISPLAY CONTRAST	45
MEMORY FUNCTIONS	45
ENABLE MEMORY.....	46
CLEAR MEM.....	46
FORMAT	46
INFO	46
SEND FILES VIA BLE	47
CONNECT THE INSTRUMENT TO THE COMPUTER	47
DATA CSV FIELDS	48
<i>Type of Measuring</i>	48
<i>CSV FILE EXAMPLE (FORMATTED)</i>	48
<i>CSV file EXAMPLE 2</i>	48
BLUETOOTH® – COMMUNICATION.....	49
ACTIVATE BLUETOOTH®	49
IR – COMMUNICATION	49
DATA FORMAT	50
IR - HAGLOF	50
BLUETOOTH - NMEA	50
BLUETOOTH BLE	51
HOW TO CALIBRATE THE COMPASS.....	52
COMPASS TEST.....	52
FIRMWARE UPGRADE.....	54
TECHNICAL SPECIFICATION	55
<i>The Instrument Coordinate System</i>	56
ERROR DETECTION	58
<i>LASER</i>	58
<i>ULTRASOUND</i>	59
<i>COMPASS</i>	59
COMPLIANCE STATEMENTS/DÉCLARATION DE CONFORMITÉ	60
WARRANTY AND SERVICE INFORMATION	61
SAFETY AND OPERATION PRECAUTIONS.....	61
CARE, STORAGE AND MAINTENANCE	61
NOTES ON BATTERIES.....	61
SOFTWARE	62

OVERVIEW

HAGLÖF SWEDEN®

Haglöf Sweden AB focuses on the development, manufacturing and marketing of modern measurement solutions for professional forest inventories and other field measurement work.

In Haglöf Sweden's unique product range you will find the world's largest assortment of increment borers and precision calipers, a variety of height and distance meters, laser rangefinders, computer calipers and complete software systems and applications.

There are over 200 companies representing the Haglöf Sweden brands around the world. This ensures customers on all continents and on more than 100 different markets quick and qualified service and support.

VERTEX LASER GEO AND LASER GEO

FEATURES

Haglöf Sweden's GEO instrument models offer outstanding capacity and versatility, for accurate and efficient field measurement operations in different situations, terrains, climates and surroundings.

The GEO instruments offer long range distance measuring with high precision laser and integrated tilt- and compass sensors for accurate 3D measurements. Results are presented in an integrated heads-up display and on a large external graphic LCD display. The VERTEX LASER GEO model includes built-in, proven reliable ultrasonic distance technology, optimized for measurements in dense forest and for circular sample plot work.

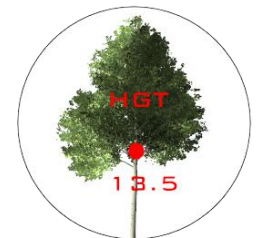

GPS AND MAPPING

The built in GPS-receiver and a 5-position numeric ID-attribute allow you to tag important data with coordinates with a simple key press. Your data is stored on a built in SSD drive and are immediately available to you when connecting the GEO standard USB 2.0 interface to any PC or Apple computer. No software installation or drivers are needed, and your field data can be opened straight in your favorite GIS- or spreadsheet application without any special converting software.



Complex operations such as area measurement, 3D mapping of targets and trail mapping have integrated functions in the GEO instruments. These functions are available without any external tools. The 3D Vector function allows you to measure horizontal targets such as canopy width or height of piles or heaps.

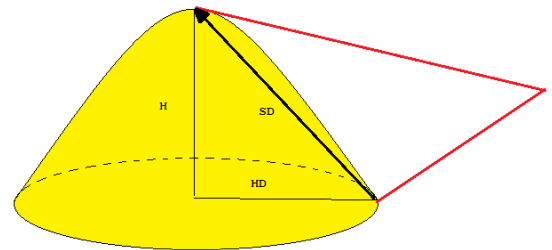
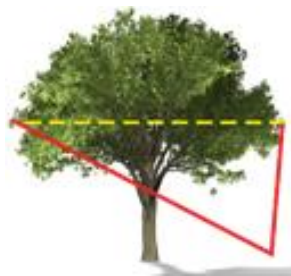

FORESTRY

The VERTEX LASER GEO model is especially suitable for forestry measurement applications. The use of an ultrasonic transponder helps you to quickly and accurately determine if a tree is in or out a circular sample plot. The ultrasound method is superior compared to alternative methods, as it can be used in dense forests and areas with thick understory.

HEIGHTS

Standard height measuring functions with laser (VERTEX LASER GEO: also ultrasound) such as 3-point, 2-point or 1 point measuring are available in the easy-to-follow menu system. The non-magnification red dot sight helps you to easier identify individual targets such as tree tops in the forest.

UPGRADES AND CUSTOMIZATIONS

Firmware in the GEO instruments can be upgraded by the user. New features are available for you to purchase and implement as soon as they are ready & released. Alternative firmware's for user specified utilization standard applications can be offered at development and license costs.

COMMUNICATION AND ENERGY

The built-in Bluetooth V4, Low Energy transceiver, enables long range wireless data transfer to your favorite handheld device. The GEO instruments have built-in, long-lasting Li-Ion battery that are charged with mini USB interface.

INSTRUMENT OVERVIEW

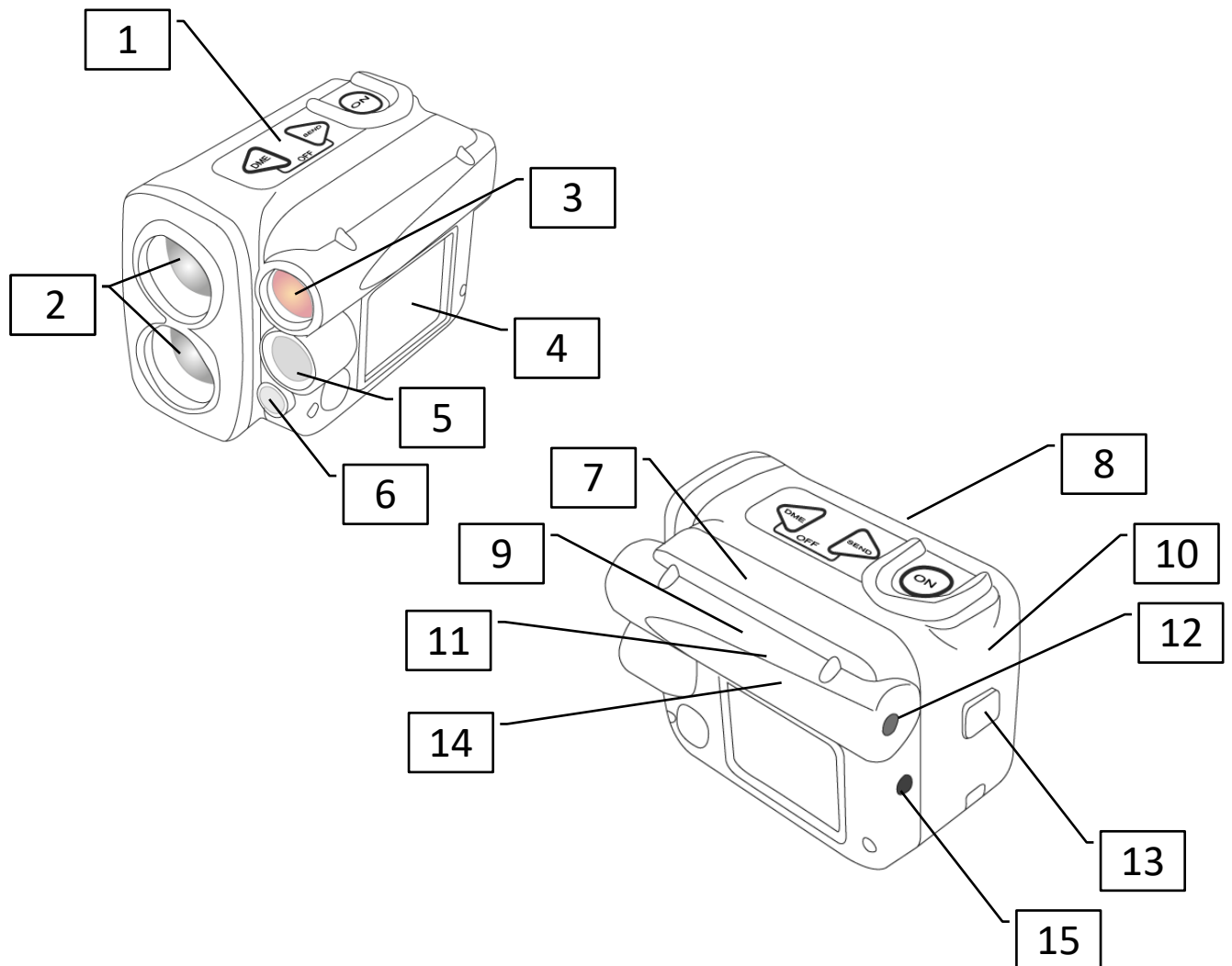

1. Buttons
2. Laser optics
3. Lens for Sight and Heads up display
4. LCD display
5. Ultrasound transceiver (VERTEX LASER GEO)
6. Ultrasound temperature sensor (VERTEX LASER GEO)
7. Bluetooth transceiver
8. Rechargeable Li-Ion battery
9. GPS receiver
10. SSD drive
11. Tilt sensor
12. Sight and Heads up display
13. USB and charge connection and protection cap
14. Compass sensor
15. IR transmitter

TRANSPONDER T3

A transponder T3 is (normally) included in the VERTEX LASER GEO instrument system.

The transponder is equipped with an ultrasonic transmitter and a receiver that communicates with the measuring instrument. The transponder can be used both for aimed/direct measuring and for circular measuring, with the 360-degree adapter. To use the transponder to measure tree heights, remove it from the adapter/spreader and pin it to the tree stem at preset height.

The T3 Transponder is equipped with a beep signal, indicating ON or OFF status. The T3 has no switch and the VERTEX LASER GEO instrument is basically used as a remote control to turn off and on. When turned on, the Transponder stays active until turned off or after approximately 20 minutes of inactivity.

The transponder uses one alkaline 1,5-volt AA battery to operate, which is placed under the battery lid.

1. Transponder housing
2. Ultrasound transceiver
3. Battery cover

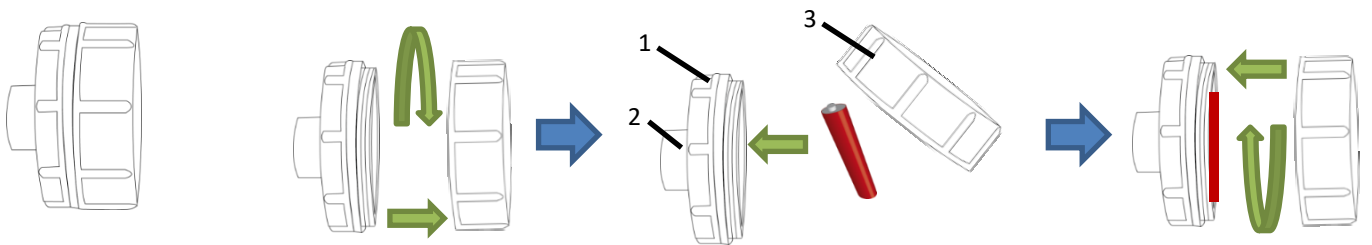

360 ADAPTER/SPREADER

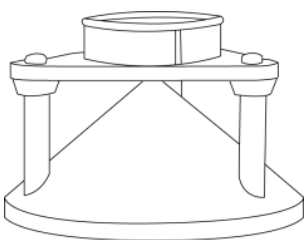

An adapter/spreader and a custom plot center staff can also be used in the Vertex Laser system. The adapter allows the ultrasound signals to spread in a full 360-degree circle for circular sample plot work.

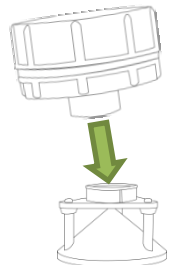

MONOPOD PLOT CENTER STAFF

The custom plot center staff or monopod is used together with the adapter for the transponder. This solution enables the user to measure in 360 degrees around the monopod, using ultrasound. The monopod is telescopic, light weight and can be height adjusted.

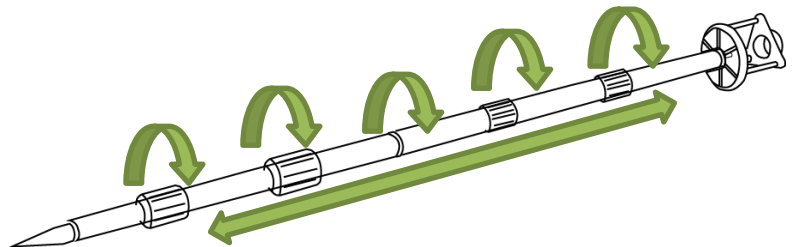

MONOPOD

Another optional accessory is a monopod, suitable when measuring thin objects and to obtain a steadier aim. The GEO instruments mount to the monopod with 1/4-20 mount. If using a monopod with the GEO instrument, it is important to use a non-magnetic monopod. If using a regular monopod staff, you will run the risk of compromising the compass in the GEO instrument. Read more under the Compass section, this user guide.

FUNCTIONS AND USE OF THE BUTTONS

BUTTONS

The GEO instrument's overlay contains three buttons: two arrow buttons and the ON button.

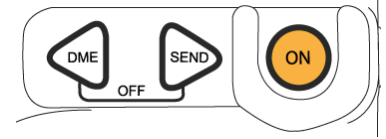

ON

One press at the ON button starts the GEO instrument. The ON button is used to select a menu command or a function; to confirm a selection or a value; and as a trigger when heights and inclination are measured. When you use the laser function to measure distances, the ON button can be kept pressed down to activate a scanning function. The laser will scan continuously until a target is obtained or the button is released. The scanning function is especially useful to measure thin objects such as power or phone lines.

ARROW BUTTONS

Use the arrow buttons - DME and SEND - to scroll between menus, and to change values and selections.

DME BUTTON

When the instrument is turned off, the ultrasonic distance measuring function can be activated by pressing the DME button.

The DME button is also used to work with the Laser. Press the DME key to temporarily change the preset Laser mode (First-, Strongest-, Last- target), to allow the laser sensor to work in best possible mode for the situation. Example: use mode **Last** to avoid the laser to hit a target in front of your main target such as grass or bushes.

SEND BUTTON

With the SEND button, data can be sent with IR and Bluetooth to an external device or saved in the internal memory while measuring. Data transfer via IR or Bluetooth is disabled when data storage is enabled.

EXIT (DME + SEND)

Press both DME and SEND buttons at the same time to step out of a menu, to interrupt a function or to turn the instrument off. The instrument has automatic turn off function that is activated after approximately 2 minutes of inactivity.

RESET

If the software in the instrument is locked, a reset can be done by pressing all keys (DME, SEND and ON).

TURN OFF

The instrument turns off after 2 minutes of inactivity. To turn off the instrument manually, press the DME- and SEND buttons at the same time (Exit) when in the main menu. If GPS or Bluetooth is activated, the instrument will hold 18 minutes before completing turn off. This is to keep GPS or Bluetooth active and ready for new measurements within the time frame of 18 minutes.

SIGHT

RED DOT SIGHT

The GEO instruments have a highly intensive red dot sight. The sight has no magnification, to simplify identification of close-by objects.

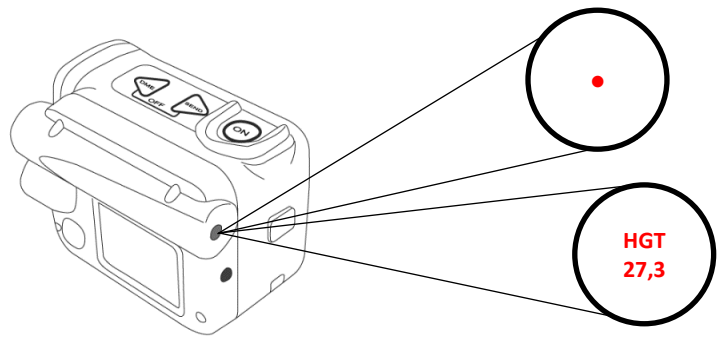

HEADS-UP DISPLAY

The sight also works as a heads-up display where various results are presented. More details are shown on the large LCD display on the left side of the instrument.

BATTERY AND CHARGING OF BATTERY

The instrument has built-in Li-Ion battery. The display shows a battery symbol with battery status in four (4) steps (100%, 75%, 50%, 0%). Charging of battery is made by connecting the mini USB cable to the Mini USB interface contact at the back of the instrument.

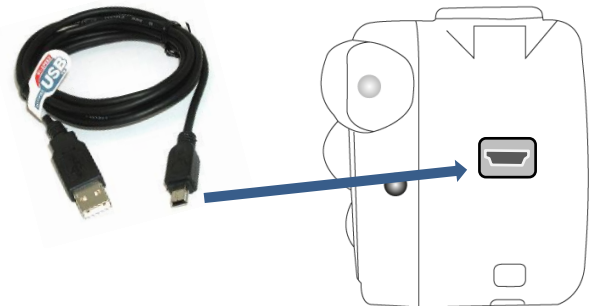

When the battery is full, charging stops automatically. The instrument should not be turned off during charging. If the battery is empty, a full charge takes approx. 3.5 hours, and a fully charged battery will last for approx. 2000 measuring operations. Change of battery, if needed, can only be done by authorized service stations.

MAIN SCREEN

1. Press ON to start VERTEX LASER GEO / LASER GEO.
2. The main menu is started.
 - a. Name of instrument
VL GEO (Vertex Laser Geo) or L GEO (Laser Geo)
 - b. Product number 1000
 - c. Version 2.8
 - d. Serial number 60001
 - e. Status Icons
 - f. Menu – "Function"

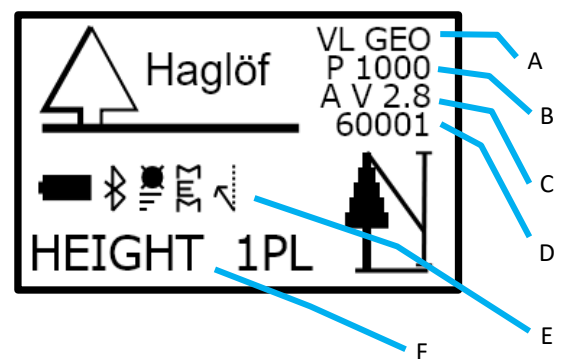

STATUS ICONS

The main menu screen shows some useful status icon.

- | | |
|-----------------------------|--|
| Icon 1: Battery level | (0%), (25%), (75%), (100%), (charging) |
| Icon 2: Bluetooth | (Bluetooth on), (connection ongoing) |
| Icon 3: GPS | (GPS enabled) |
| Icon 4: Memory | (Memory storage enabled) |
| Icon 5: Compass declination | (Compass declination enabled) |

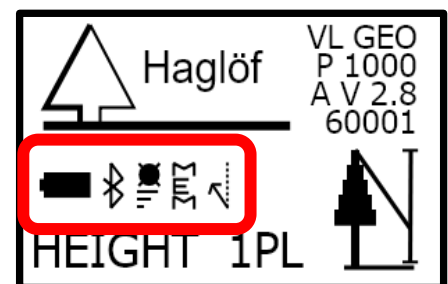

MENU SCHEME

Use the DME- or SEND button to change current menu. Press ON to step to next position. To exit a menu, press the DME- and SEND buttons at the same time (Exit).

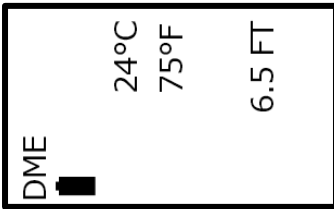

Shortcut to DME function (ultrasound): Press DME button when the VERTEX LASER GEO is turned off.

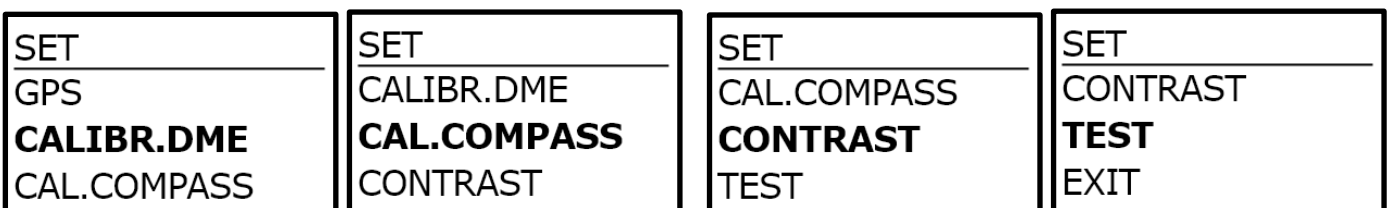
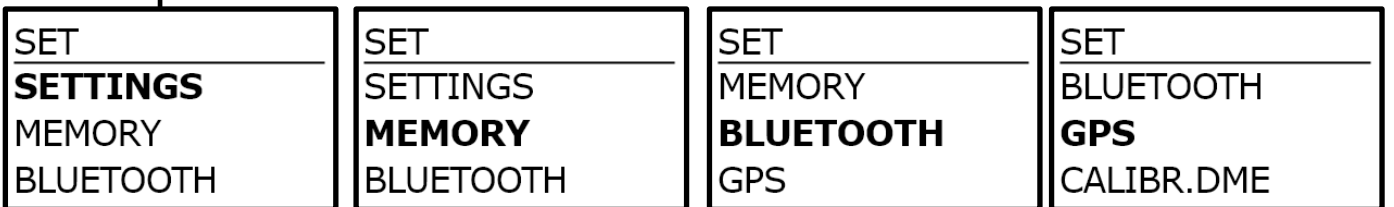
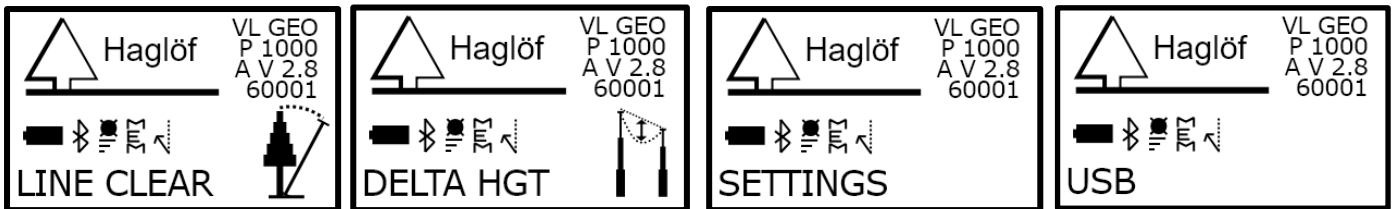
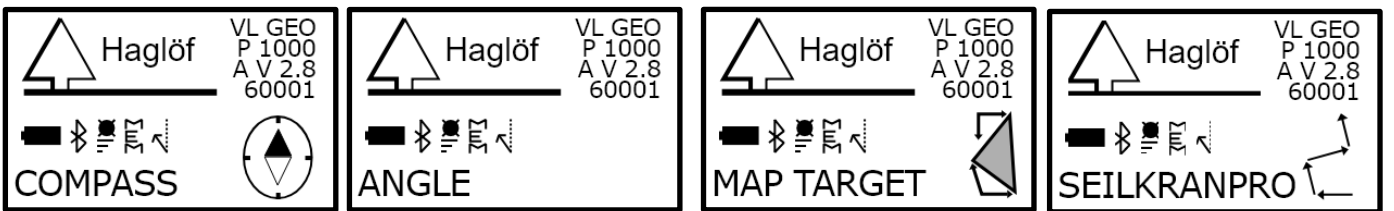
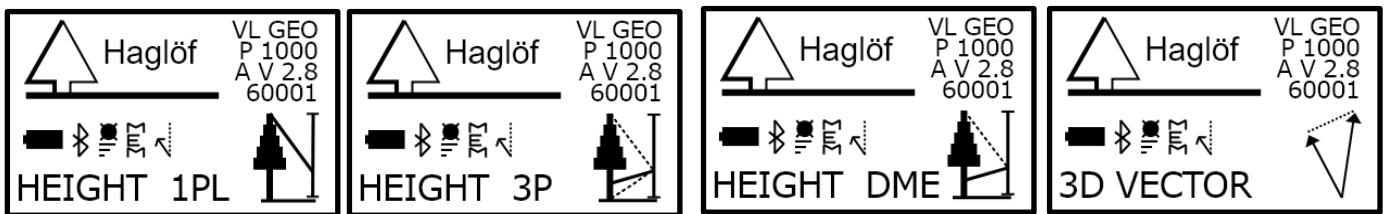

SETTINGS

In the SETTINGS menu, all settings are made to measure heights, distances and angles.

1. Press ON to activate the GEO instrument.
2. Select **SETTINGS** and press ON to confirm. Choose **SETTINGS** in the **SET** menu and press ON.

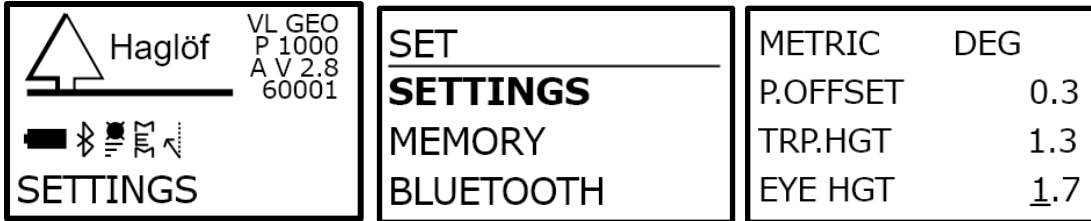

3. Use the DME or SEND button to change values and settings. Press ON to step to the next field. Settings are saved when you have stepped through all fields. To quit, press the DME- and SEND buttons at the same time.

METRIC/FEET:

Select if to use metric or feet for heights and distances.

DEG/GRAD/%:

Select unit for inclination/angles as DEG (degrees 0...360), GRAD (grades 0...400) or % (percentage).

P.OFFSET:

The Pivot offset refers to the distance from the front of the instrument to an imagined point where the extension of the aiming line from the tree and the top of the tree coincide.

The point is located behind the neck of the instrument operator. The Pivot offset should in normal cases be set to approx. 0,3m/1.0ft.

Since the Instrument will presume that the distance to an object is right under the required height of the target, half of the diameter value should be added to the Pivot offset to compensate for the tapering of a tree. When measuring tree heights, it is recommended to add half of the mean diameter in the stand/area where you are currently measuring.

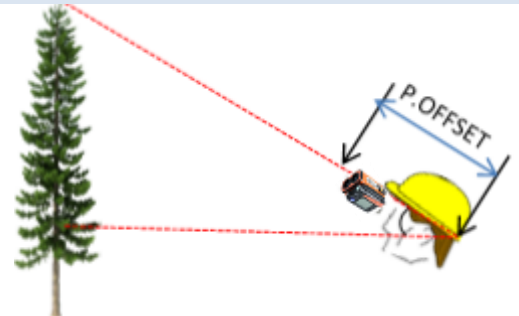

TRP.HGT:

The height of the transponder or other point of reference should be equal to the distance from the ground level to the point of reference. In normal cases, the **TRP.HGT** refers to the center of the transponder T3 or zero (0) when the point of reference is equal to ground level or the lowest part of the measurement object. In menu **HEIGHT DME**, the **TRP.HGT** is always added to the height. The normal height value for the T3 transponder is 1.3m/4.3ft = breast height.

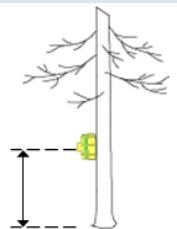

EYE HGT:

The value for **EYE HGT** is equal to the eye height of the operator from ground level. This value is used in the 1-point laser function to calculate the total height from ground level.

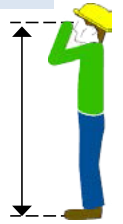

M.DIST:

In the **HEIGHT DME** menu, a manually measured and input distance can be used where the distance to the object is known, for example a fixed distance between poles. M.DIST can also be used if you experience problems to measure distances with ultrasound and/or laser, for example if a large object is blocking the object to measure. Note! The accuracy of a manually measured and input distance affects the accuracy of the height result. Remember to set the correct transponder height **TRP.HGT** since this value is also used when using a manually input distance value, see above.

LASER MODE:

Set if the laser is to react to the first object (FIRST) it hits; the object that gives the strongest signal (STRONGEST) or react to and measure the last target it hits when you measure distances (LAST).

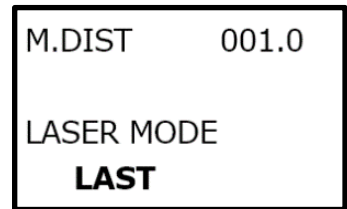
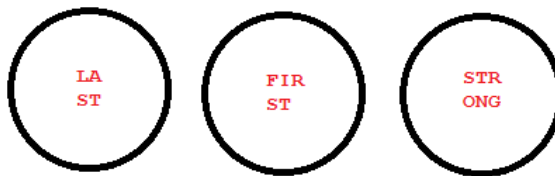

You can temporarily switch the laser mode by pressing the DME button, and toggle between LAST-, FIRST- and STRONGEST target. Note that the laser will go back to default mode after one measurement.

BAF:

BAF is used in the DME menu and normally to measure a distance with ultrasound (VERTEX LASER GEO). The BAF function is also available when working with laser. When performing a "relascope" measurement operation, the built-in BAF function can be used to control the minimum tree diameter 'Ø' for a plot. When working with relascope or prisms, some trees in the plot can be difficult to see and to determine if to include the tree in the plot or not. By measuring the distance from the plot center, the Instrument can calculate a minimum diameter for the tree to be included in the plot. Built-in BAF factors are: 0.5, 1, 2, 3, 4, 5, 6, 7, 8, 9 (m2/ha), alt. 5, 10, 15, 20, 25, 30, 35, 40, 45, 50 (ft2/acre). Use the option '- -' to disable the BAF function.

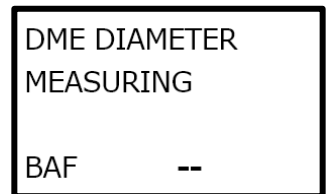

In leaning (inclining) terrain, the VERTEX LASER GEO can compensate for the inclination and calculate the diameter measure. In such cases, use the **ANGLE** function in the menu to measure the distance and angle from the tree to the reference point (see section **ANGLE** in this user's guide).

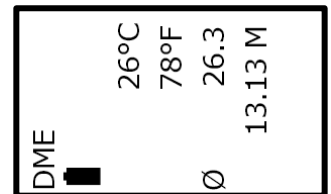

AZIMUTH

Select unit for the compass as 360° (degrees 0...360) or 400' (grades 0...400). This setting only applies to showing the compass value in the display. Compass values in CSV- and KML-files are always saved in 360° format.

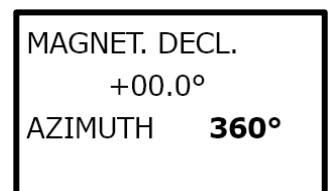

MAGNETIC DECLINATION:

Set the local magnetic declination -90.0°-+90.0°.

The magnetic declination in the Instrument is factory set to 0.0. Before using the GEO instrument, you may need to enter a magnetic declination for your geographic area. The declination correction is (only) important if your data will be used in a GIS software or if true north azimuth is required.



The Earth is surrounded by a magnetic field, and any unobstructed magnetized object, or North-seeking compass, will orient itself with the magnetic North and South Poles. Magnetic declination (also known as magnetic variation) is the difference in the bearing, or angle, from your position to true North (also known as the North Pole) and magnetic North, which is located somewhere in Northern Canada. The magnetic declination varies significantly from location to location in the world and slightly also from year to year. It is important to find out the correct magnetic declination for your area to ensure that the calculations your Instrument performs are correct.

Choose the **SETTINGS** menu to set current declination for the position you are at, between true north and magnetic north. The Instrument will automatically adjust the measured compass angle with the set declination. A declination between -90.0° and +90.0° can be set and obtained.

1. Press ON to start the GEO instrument.
2. Select **SETTINGS** and press ON to confirm selection. Then choose **SETTINGS** in the SET menu and press ON.

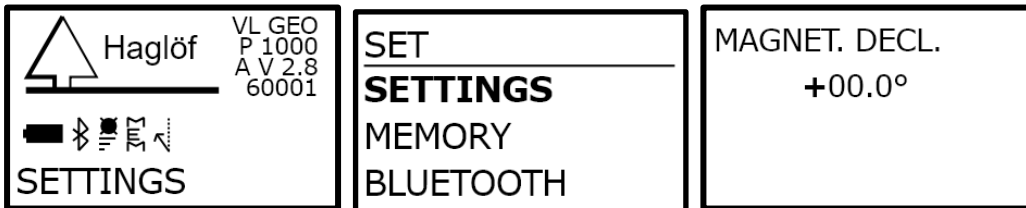

3. Press ON, step by step, until **MAGNET. DECL** is shown.
4. Use the DME- or SEND button to change the sign ('+'/'-'), then press ON to step to next position.
5. Use the DME- or SEND button to change digit at current position ('+'/'-'). Press ON to go to next position.
6. Repeat step 5 above until all digits are defined.

See <http://www.magnetic-declination.com/> for latest info about magnetic declination.

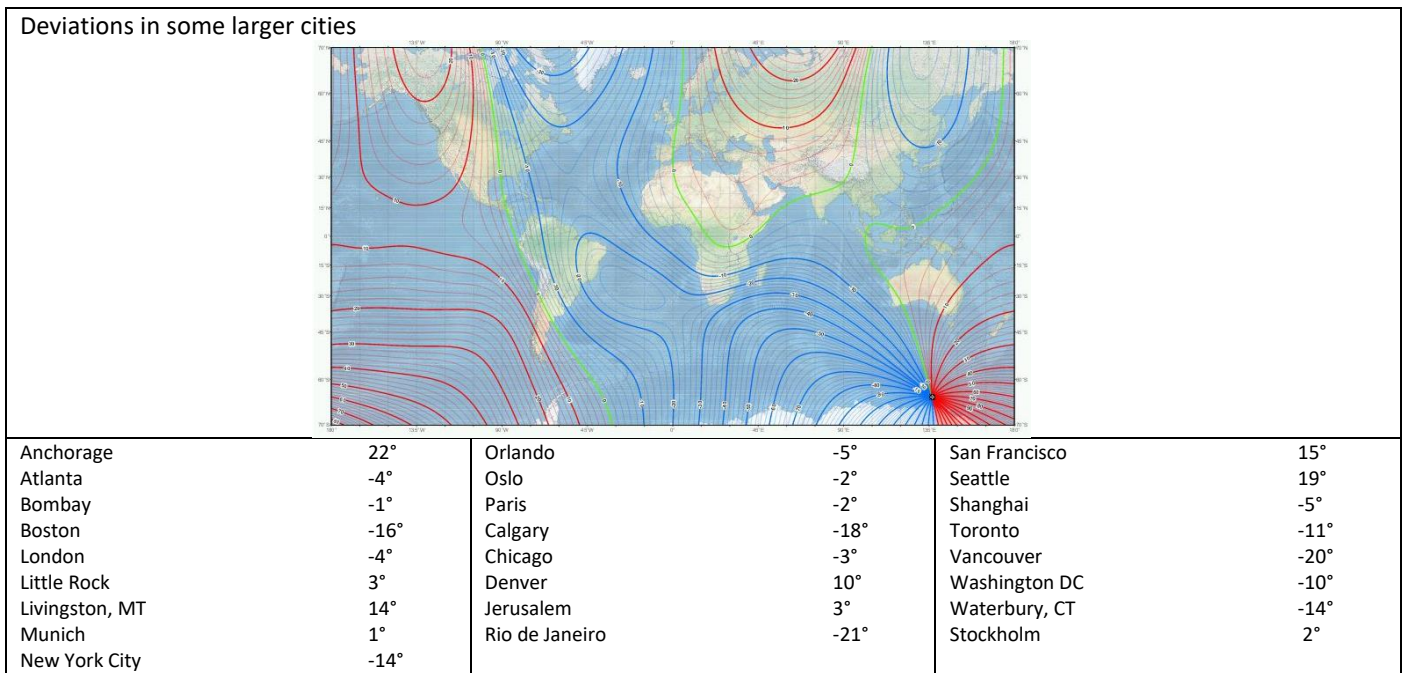

DISTANCE MEASURING

For the LASER GEO instrument model, descriptions for the laser method are valid.

There are two methods to measure distances in the VERTEX LASER GEO: laser or ultrasound. Which method to use for a field operation is determined by factors such as terrain composition and understory. Current weather conditions can also be of importance. The laser function is often used to measure heights and to measure long distances in open terrain.

In combination with the T3 transponder, ultrasound measuring can be used when working in circular sample plots and to measure short distances in dense terrain/forests.

DISTANCE MEASURING METHODS

LASER

Laser can be used to measure the distance to targets such as trees, power lines or buildings. Laser can also be used to work with the BAF function, although the ultrasound method (VERTEX LASER GEO) is more commonly used for this application.

The instrument laser sensor is of optimal quality and offer accurate results and extensive measuring range. The laser emits invisible, eye safe infrared energy pulses that reflect off the selected target back to its optical receiver. The distance is calculated by comparing the return time to the speed-of-light constant and presented in the instrument display. The ability of a laser sensor to measure to a target depends on the target's reflectance and any interference between the sensor and the target, such as dust, fog, foliage or other. Reflectance is determined by color, opacity, distance and the reflection angle as well as the density of any ambient interference between the sensor and the target. A lighter target is more reflective than a darker one and thick dust will reduce the signal strength more than light dust. An adjustable laser filter allows for flexible measuring, where you can select to measure the closest object, the farthest object or the object that submits the strongest signal.

Use the DME button to temporarily change the preset Laser mode (First-, Strongest-, Last- target) allowing the laser to work with the best possible mode for the situation. Example: Use **Last** mode to avoid that the laser sensor hits a target in front of your main target such as grass or bushes.

ULTRASOUND

Vertex Laser Geo: Together with the T3 transponder, ultrasound can be used to measure the distance to a plot center and to obtain sample plot radius. You can work with the BAF Basal Area Function to determine if a tree is to be included in a sample plot study. Ultrasound can be used in dense forests; a big advantage compared to other methods.

The Vertex ultrasound method uses ultrasonic signals to obtain a distance reading from the measuring instrument to the T3 transponder. The height is calculated trigonometrically with the measured results on distance and angle. The T3 Transponder works both in a 60° mode for direct height measuring, for example pinned on a tree stem; or in a 360° mode when mounted onto the monopod plot staff – great when working in circular sample plots with the Vertex Laser Geo ultrasound method.

Ultrasound technology can be used when the target is completely or partially covered and hard to visualize. The methodology is useful in circular sample plots, and if the reference point (plot center) is covered by understory such as shrubs and bushes. When measuring the angle to the reference point, the horizontal distance can be calculated.

Working with factor gauges or prisms can be difficult in areas with heavy underbrush, and poor sighting can prevent a correct diameter evaluation. With the instrument built-in BAF function (Basal Area Function), the minimum tree diameter for trees to be included in the plot can be featured, by measuring the distance from the tree to the reference point/plot center.

HEIGHTS

The GEO instruments offer different methods for height measuring applications:

HEIGHT 3P – 3-POINT MEASURING WITH LASER

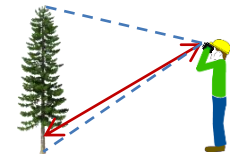
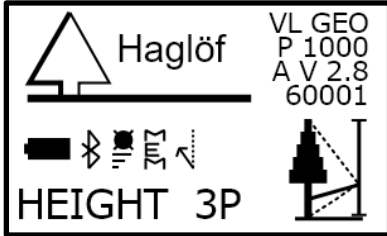

Distance and angle to optional part of target object measured with laser. The angle – inclination – is measured at the base and at the highest (top) part of the object.

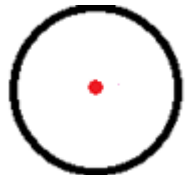

1. Press ON to activate the instrument.
2. Select HEIGHT 3P and press ON to confirm your selection.
3. When the red dot sight is turned on and the text **AIM AND PRESS ON TO FIRE LASER** is shown on the LCD display, aim at optional point on the object and give a short press at ON to measure the distance and angle to this point. Aim at the point until a short beep goes off and a result is shown in the heads-up display.
4. A temporary height result to the point you are aiming at from ground, including the preset eye height, is shown.
5. If you have missed the target, you can start over by aiming at the point, and give a quick/short press at ON.
6. Note: If needed, use the DME button to temporarily change the preset Laser mode (First-, Strongest-, Last- target) to allow the laser to work in optimal mode for the current measuring situation. Example: use **Last** mode to avoid the laser to hit a target in front of your main target such as grass or bushes.
7. Aim at the base or other point of reference that you have chosen to measure from on the object. Press ON and keep pressing until a beep goes off and the aiming dot is turned off. Release the ON button.
8. Aim at the top (or other height) on the object and keep pressing ON until a beep goes off and a result is shown in the heads-up display. Release the ON button.
 - a. **SD** Slope Distance (m or feet)
 - b. **HD** Horizontal Distance (m or feet)
 - c. **DEG** Angle (Degree, % or Grads)
 - d. **H1** Height (m or feet)
9. The height, calculated from the three (3) measured reference points, is now shown in the display.
10. Repeat point 8 to measure more heights on the same object.

SD	9.7	a
HD	9.6	b
DEG	- 20.9	c
H1	27.3	d

Press both DME and SEND buttons to step out of menu.

HEIGHT 1PL – 1-POINT MEASURING WITH LASER

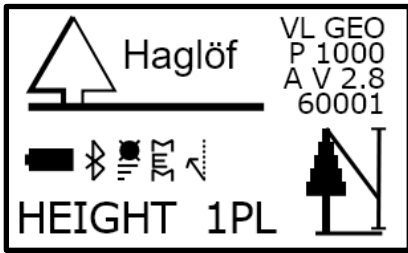

Distance, azimuth and angle to an optional part of the object are measured with laser.

To work with the Height 1-PL – (also: one-point or one-shot) method, the user must be positioned on the same horizontal level as the base of the target object. The user’s eye height -**EYE.HGT** - needs to be set in the settings menu.

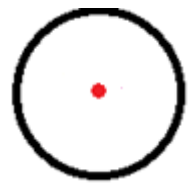
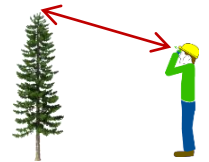

1. Press ON to activate the instrument.
2. Select **HEIGHT 1PL** and press ON to confirm your selection.
3. When the red dot sight is turned on and the text **AIM AND PRESS ON TO FIRE LASER** is shown, aim at the top (or other height) on the target object and give a short press at ON to measure the distance and angle to the top. Aim at the point until a short beep goes off and a result is shown in the heads-up display.
 Note: If needed, use the DME button to temporarily change the preset Laser mode (First-, Strongest-, Last- target) to allow the laser to work in optimal mode for the current measuring situation. Example: use **Last** mode to avoid the laser to hit a target in front of your main target such as grass or bushes.
 - a. **SD** Slope Distance (m or feet)
 - b. **HD** Horizontal Distance (m or feet)
 - c. **H** Height (m or feet)
 - d. **DEG** Angle (Degree, % or Grads)
 - e. **AZ** Azimuth (Degree or Grads)
4. The height (**EYE HGT** included) is now featured in the display.
5. Repeat point 3 for a new height.

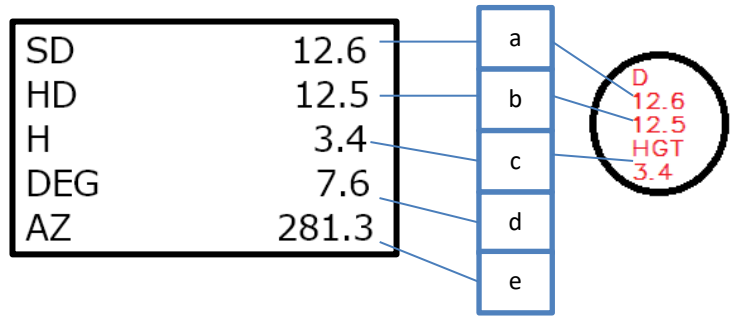

Press both DME and SEND buttons to step out of menu.

HEIGHT DME – 2-POINT MEASURING WITH ULTRASOUND

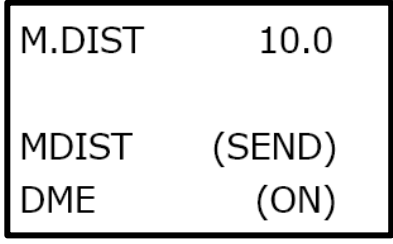
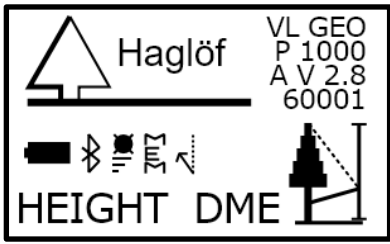

VERTEX LASER GEO: Distance and angle to reference point measured with ultrasound and a transponder. The top angle is measured.

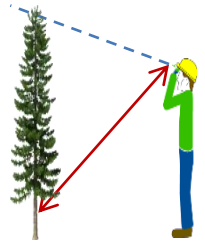

1. Make sure that the VERTEX LASER GEO instrument is turned off.

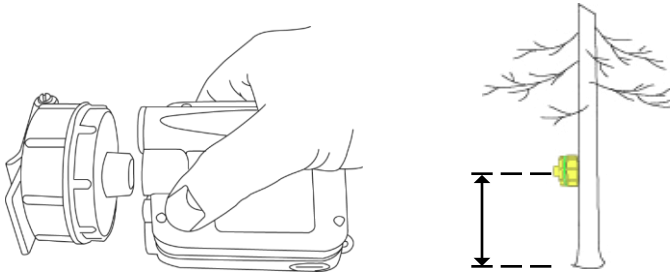

2. Start the T3 transponder by holding the ultrasonic transceiver on the VERTEX LASER GEO instrument close to the center of the transponder and press the DME button on the VERTEX LASER GEO instrument. Wait for two short beeps from the transponder. The T3 transponder is now ON and will stay ON until turned off or after approx. 20 minutes of inactivity when automatic turn off. To turn the T3 transponder off (OFF), repeat the procedure described above and wait for four (4) short beeps.

Place the transponder at the correct height position (**TRP.HGT**).
Turn off the measuring instrument.

3. PRESS ON to activate the VERTEX LASER GEO instrument.
4. Select **HEIGHT DME** and press ON to confirm your selection.
5. Aim at the T3 transponder and press ON to measure distance and angle. Aim at the T3 until a beep goes off and a result is shown in the heads-up display.
6. Aim at the top (or other height) on the target object and press the ON button until another beep goes off and a result is shown in the heads-up display. Release the ON button.

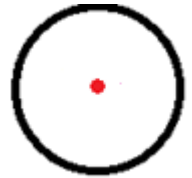

- a. **SD** Slope Distance (m or feet)
- b. **HD** Horizontal Distance (m or feet)
- c. **DEG** Angle (Degree, % or Grads)
- d. **H1** Height (m or feet)

7. The height (**TRP.HGT** included) is shown in the display.
8. Repeat point 6 for more heights at the same object.

SD	9.7	a
HD	9.6	b
DEG	- 20.9	c
H1	27.3	d

Press both DME and SEND buttons to step out of menu.

HEIGHT DME – 2-POINT MEASURING WITH MANUAL DISTANCE

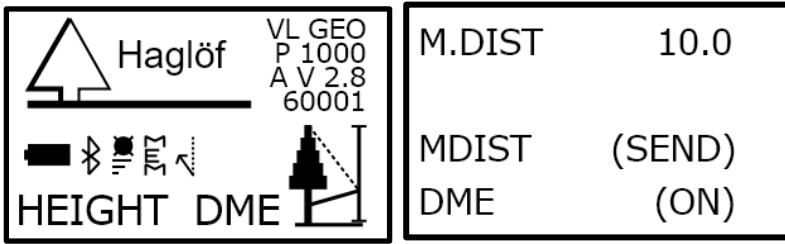

1. Press ON to activate the instrument.
2. Select **HEIGHT DME** and press ON to confirm your selection.
3. Accept the distance value shown in the display (**M.DIST**) with a short press on the SEND button. If this value is incorrect, it can be changed in the **SETTINGS** menu. **M.DIST** refers to the distance between the eye height and the point of reference.
4. Aim at the point of reference at a known height, **TRP.HGT** in menu **SETTINGS**, set to zero (0) if the point of reference is equal to ground level. Press ON to measure the angle to the point of reference. Keep pressing the ON button until a short beep goes off and a result is shown in the heads-up display. Release the ON button.
5. Aim at the top (or other height you wish to measure) on the object and keep pressing ON until a short beep goes off and a result is shown in the heads-up display. Release the ON button.
6. The height (**TRP.HGT** included) is featured in the display.
 - a. **SD** Slope Distance (m or feet)
 - b. **HD** Horizontal Distance (m or feet)
 - c. **DEG** Angle (Degree, % or Grads)
 - d. **H1** Height (m or feet)
7. Repeat point 5 for more heights.

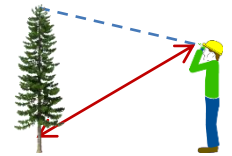

Press both DME and SEND buttons to step out of menu.

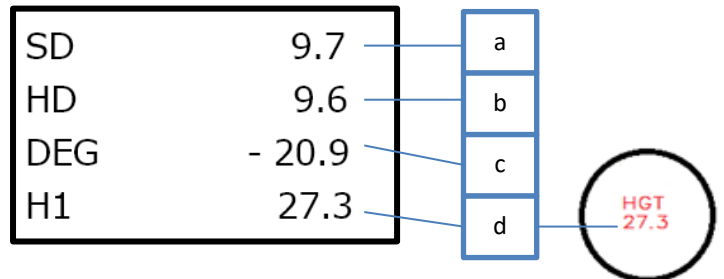

Note that the accuracy of the manually input distance (**M.DIST**) affects the accuracy of the height measuring result.

SEILKRANPRO (MAP TRAIL)

The **SEILKRANPRO** function will enable you to collect target coordinates in a logical sequence by using either the laser or the ultrasound method, pitch and azimuth data. The SEILKRANPRO function is useful when mapping different pathways, possible tracks or roads where GPS data is not accurate enough or when mapping for a cableway system in the forest to haul out logs. If the forest is dense, the ultrasonic method can be used to measure distances.

The instrument's built-in compass shows direction continuously in the display before completing a measurement routine. This function guides the user to hit a target in the desired direction.

Normally, your last target will be your next reference. However, a reference can be moved with the built-in GPS or by using the laser or DME. This is used for example when the next target is not visible from your reference point, and you must move away from the trail to be able to see it.

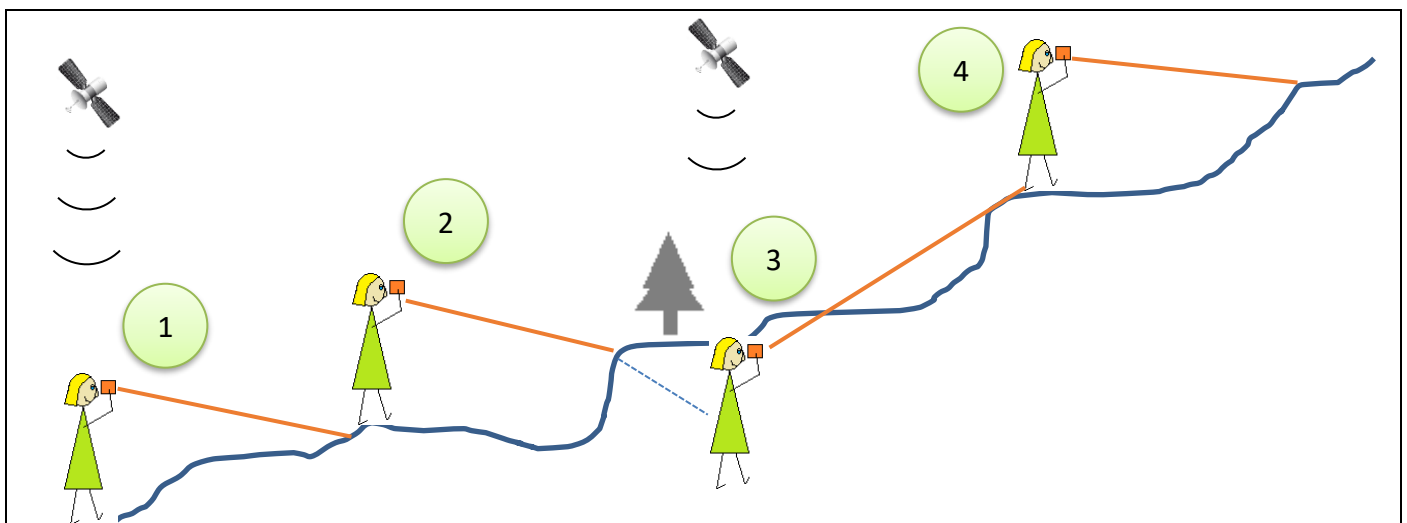
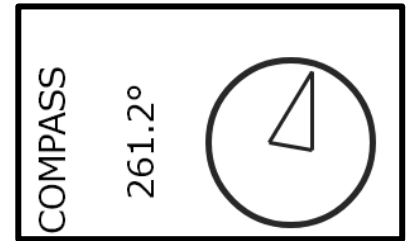

<p>1. Starting point Enter a 5 position ID for your trail; Ex: 12345.</p> <p>Use laser to measure to the first target.</p> <p>A GPS coordinate will be stored with this starting point (if GPS option is enabled). Go to the target.</p>	<p>2. Use laser to measure to the second target.</p> <p>Go to the target.</p>	<p>3. If your next target is not visible from the trail, move to a position where this target is visible and use the GPS to store your position. Use laser to measure to the third target.</p> <p>Go to the target.</p>	<p>4. Use laser to measure to your fourth and last target.</p> <p>Your target data is now stored in a CSV- and a KML-file.</p>
--	---	---	--

DISTANCE WITH DME OR LASER

The GEO instruments default distance measuring mode is the laser method. The user may switch to working with ultrasound (VERTEX LASER GEO only) in the sub menu before beginning the measuring operation. When using ultrasound (DME), the transponder T3 must be placed at the target. In most cases, a second user stands at the target object, and holds the transponder at set target height **TARGET HGT**, normally 1.3m/4.3ft above the ground. If working in the DME mode, the transponder T3 should be activated before the measuring work starts. Select **DME** and turn on the T3 transponder by holding the ultrasonic transceiver on the VERTEX LASER GEO instrument close to the center of the transponder and press the ON button

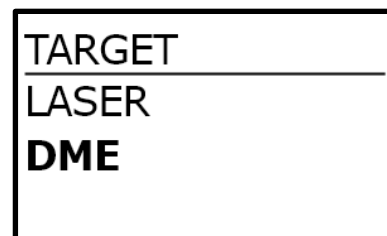
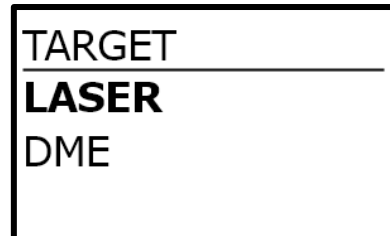
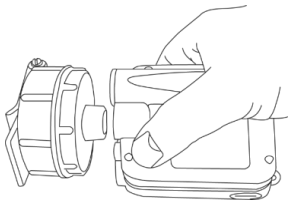

SEILKRANPRO STEP BY STEP

1. Press ON to start the GEO instrument.
2. Select menu **SEILKRANPRO** from the main menu and press ON button.

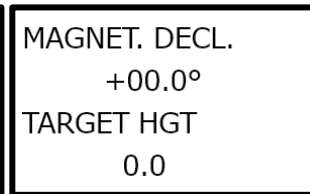
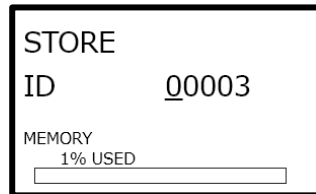

3. Enter an ID for your trail. This ID is used to name the data files. Use the Send button to move the cursor and the DME button to change the digit ('0'-'9') at the cursor position. Press the ON button to store the ID.
Note! if entering an already existing ID, data will be added continuously to the trail.
4. When the text **MAGNET. DECL** is shown in the display then enter the magnetic declination for the local area.
Note! it is of great importance that correct magnetic declination is set. Otherwise the GEO instrument will show an erroneous direction to the endpoint.
5. Use the DME- or SEND button to change the sign ('+'/'-'), then press ON to step to next position.
6. Use the DME- or SEND button to change digit at current position ('+'/'-'). Press ON to go to next position. Repeat until all digits are defined.
7. Continue with entering the **TARGET HEIGHT**. The Target Height is used as the reference height at the targets on the trail. If shooting at ground level, set Target Height to 0.0.
Note! remember to always shoot the next target on the trail at Target Height.
8. Go to the start point of the trail.

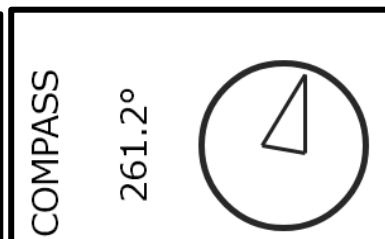
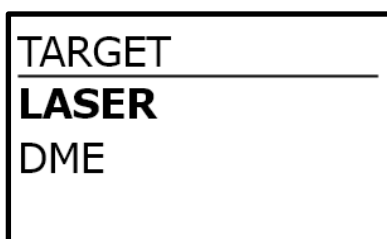

9. The Instrument is now ready to measure the first target. Select **LASER** or **DME** method and Press the ON button to go to the measuring menu.
Aim on the next target, at Target Height, and press ON to start measuring. Keep the Instrument still until a signal can be heard and a result is shown in the display. If the obtained target data seems reasonable, press the **Send** button to store this target data. If not, press ON to re-measure the target.

COMPASS 261.2° 	SD	10.6	3D	6	FIX
	HD	10.5	UTC	05:46:06	
	H	3.2	N	6310.71118	
	DEG	8.1	E	1704.15781	
	AZ	261.2	N8	CEP 1.1	

The GPS will start automatically (if GPS is enabled) to map your starting position when you store your first target. This is useful if you wish to import data to a GIS software later. The GPS data will be averaged until you press the ON button. The averaging can be restarted with the DME button.

Note that only the GPS x- and y-coordinates are used (UTM). The z- coordinate is calculated from the GEO instrument’s height data, with much higher accuracy than the GPS altitude data. To ignore GPS data, press Escape (press both DME- and SEND buttons at the same time).

- The seq (SEQ) nr and the total length (SUM) of the trail are shown in the display. Move to the target. Press the ON Button to enter a new reference menu.

MOVE TO TARGET! SEQ 1 SUM 11 m

- Select **LAST TARGET** for your new reference or, if needed, select menu option **OFFSET**. Then select between **USE LASER** or **USE DME** to move to another point of reference, outside the trail, to get a better view of your next target. You can also **USE GPS** if you must move to see your next target. Note that the GPS’ z coordinate is not used. When you move to your new point of reference, make sure to be at the same height level as your last target.

REFERENCE <hr/> LAST TARGET HEIGHT OFFSET	OFFSET <hr/> USE LASER USE GPS USE DME
---	--

- Use menu option **HEIGHT** to measure a height of your target.

LASER:

- Aim at an optional part of the Target and give a short press at ON to measure distance and angle to the point. Aim at the point until a short beep is heard and a result is displayed.
- Aim at the base of the Target. Press ON and keep pressed until a beep is heard and the red dot sight blinks briefly. Release the button.
- Aim at the top of the Target and keep ON pressed until a beep is heard. The calculated height is presented in the display.
- Press **Send** button to store the height or ON to go back to REFERENCE menu.

DME:

- Place the transponder on the target at Target Height. Aim on the transponder and give a long press on DME-button to measure distance and angle to the transponder. Aim at the transponder T3 until a beep is heard and a result is shown in the display.
- Aim at the top of the Target and press ON until a beep is heard.
- The calculated height, Target Height included, is presented in the display.
- Press **Send** button to store the height or ON to go back to REFERENCE menu.

REFERENCE
LAST TARGET
HEIGHT
OFFSET

AIM AND
PRESS ON TO
FIRE LASER
OR PRESS DME

- Repeat points 9-12 to store next target.
- When ready, select **FINISH** to finalize the trail.

TRAIL LENGTH

The total length (sum of all slope distances) of your trail is shown in the last screen.

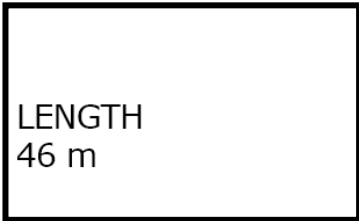

TRAIL CSV DATA

Trail data is available in the Instrument in library **VL_GEO:\DATA** or **L_GEO:\DATA**.

- Press ON to start the GEO instrument.
- Connect your instrument to a computer with a mini USB cable.
- Your Trail data is found in file TRAILXXX.CSV (csv file) and in TRAILXXX.KML (Google Earth file) where XXX is the ID for the Trail.
- Copy/move your files to your PC for backup and use your favorite spreadsheet or GIS software to open your data files. The KML file can be opened in Google Earth.

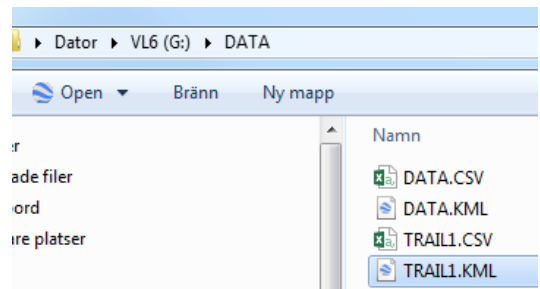

EXAMPLE GOOGLE EARTH FILE, KML FILE

Each target in the KML file is defined as "PXXX, Y" where 'XXX' is the Trail ID and 'Y' is the measuring sequence. The KML file can be open in Google Earth and can help the user to make a visual quality check of the data. In the example to the right here, the GPS is used as reference for target P1,3.



MAP TARGET

The **MAP TARGET** function is useful for 3D mapping of different types of larger targets, such as buildings and piles. The same function can be used to calculate 2D areas, such as size of clear-cut areas, inside building areas and similar.

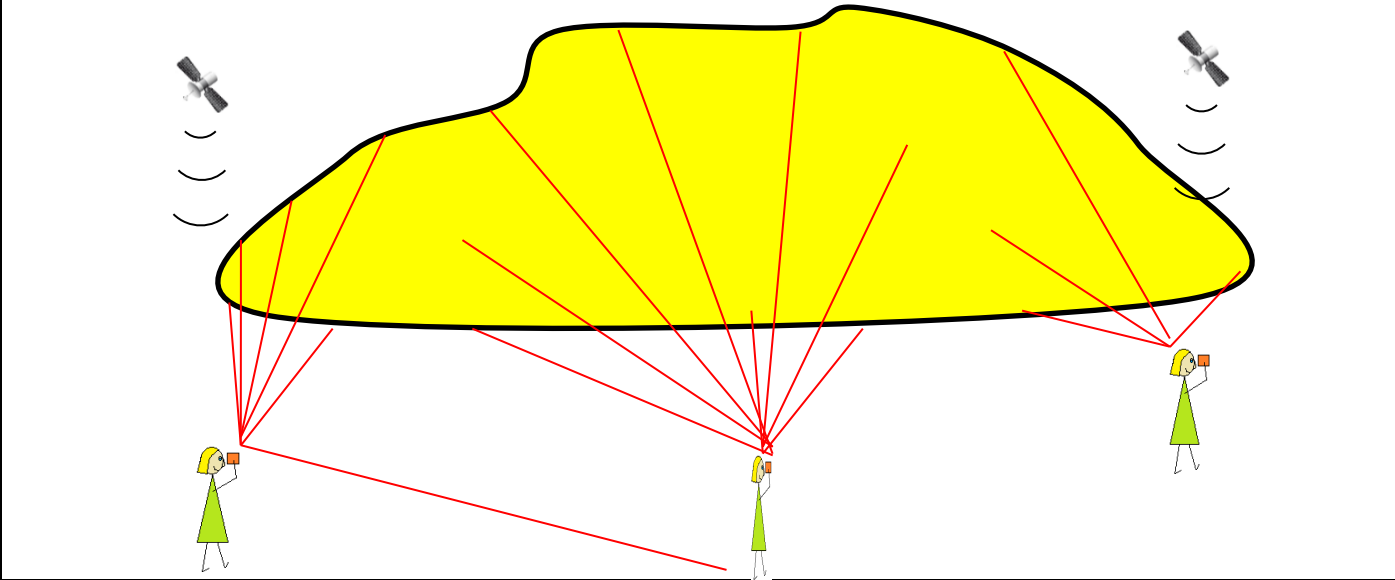

<p>1. Starting point Enter a 5 position ID for your target, for example 12345.</p> <p>Use laser to measure one or several target positions.</p> <p>A GPS coordinate will be stored with this first reference point (if the GPS is enabled).</p> <p>Use laser to measure to next suitable reference point.</p> <p>Move to the new reference point.</p>	<p>2. Second reference point.</p> <p>Use laser to measure one or several target positions.</p> <p>Use GPS or laser to measure to next suitable reference point.</p> <p>If using GPS, move to the next suitable reference point before you start the GPS.</p>	<p>3. Third reference point</p> <p>Use laser to measure one or several target positions.</p> <p>Continue to take new reference points and target positions until the target is fully covered.</p> <p>Your target data is now stored in a CSV- and KML file.</p>
---	--	---

Make multiple measurements from one or several reference points to the target. Use laser or GPS to define your reference points.

MAP TARGET STEP BY STEP

1. Press ON to start the GEO instrument.
2. Select menu **MAP TARGET/MAP TARGET** from the main menu and press the ON button.

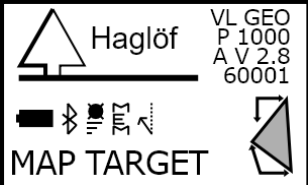
	<p>METHOD</p> <p>MAP TARGET</p> <p>MAP GPS</p> <p>GPS AREA</p>	<p>STORE ID 00003</p> <p>MEMORY 1% USED</p>	<p>AUTOSAVE VALUES? MAP3</p> <p><input checked="" type="checkbox"/></p>
---	---	---	---

3. Enter an ID for your target. This ID is used to name the data files. Use the Send button to move the cursor and the DME button to change the digit ('0'-'9') at the cursor position. Press ON to store the ID. Note! if entering an already existing ID, data will be added continuously to the object that is being measured.
4. Select if values should be automatically saved or only saved when pressing the **Send** button.
5. The Instrument is now ready for the first target. Press ON to go to the measuring menu.

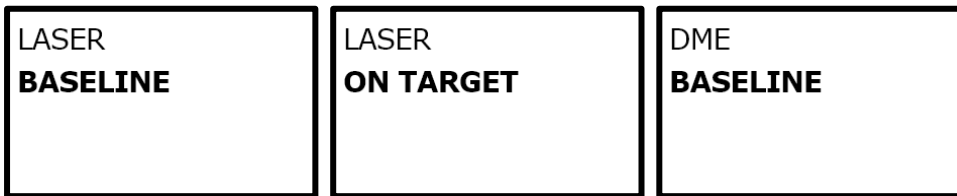

6. Start by selecting type of point to measure. Use DME and SEND buttons to shift type and press ON to start measure. All subsequent points will be of the same type until a new choice is made. Select between:
- LASER BASELINE** – if the target point should represent a point on the baseline of the object. Use laser to measure.
- LASER ON TARGET** – if it is a point on the target other than a point on the baseline. Use laser to measure the point.
- DME BASELINE** – use ultrasound and a transponder to measure a point on the baseline of the object (VL GEO only). It is of importance that the baseline points are measured in a specific direction. If you are walking counterclockwise around the object then measure the points on the baseline from left to right, and vice versa.
7. Aim and press ON to measure with laser. Keep the instrument still until a signal is heard and a result is displayed.
- Autosave values:** The target data will be automatically saved. If the data was erroneous then press **SEND** button to delete the last measurement.
- No autosave:** If the target data seems reasonable and the laser has hit the target, press **SEND** to store the target data. If not, re-measure the target.

The GPS will automatically start (if GPS has been enabled) when you store the first target, to map your starting position. This is useful if you wish to import your data to a GIS software later. The GPS data is averaged until you press the ON button. The averaging can be restarted with the DME button.

Note that only the GPS x- and y-coordinates are used (UTM). The z- coordinate is calculated from the GEO instrument's height data, that offer much higher accuracy than the GPS altitude data. To ignore GPS data, press Escape (DME- and Send buttons at the same time).

AIM AND PRESS ON TO FIRE LASER	SD 10.6 HD 10.5 H 3.2 DEG 8.1 AZ 324.9	3D 6 FIX UTC 05:46:06 N 6310.71118 E 1704.15781 N8 CEP 1.1
--------------------------------------	---	--

8. Repeat point 7 until you have a good coverage of the target. Press Exit to shift type of target point. If BASELINE was chosen then ON TARGET will be suggested.
9. Repeat point 7 again until you have a good coverage of the target. Press Exit to define a new reference point.
10. Select **USE LASER** for your new reference or **USE GPS** if you are unable to use the laser due to poor sighting. It is possible to repeat **USE LASER** in several steps until you reach a new reference. If you select **USE GPS**, make sure not to activate this menu until you are standing at your new reference point. Note that the z coordinate from the GPS is not used. For the VL GEO the option **USE DME** is also available, where you can use ultrasound and a transponder to move to the next reference point. When you move to your new reference point, make sure to be at the same height level as your last target. If your target is ready, select **FINISH** to finalize the mapping or **RETURN** to add more target positions from the current reference point. Before selecting **FINISH**, make a new reference point to the point from where you started to measure the object (optional). This can be used to afterwards determine the accuracy of the measurement.

NEW REF. USE LASER USE GPS USE DME	NEW REF. USE LASER USE GPS USE DME	NEW REF. USE GPS USE DME RETURN	NEW REF. USE DME RETURN FINISH
--	--	---	--

11. Move to your new reference point.

MOVE TO
NEW REF.!

MOVE TO
NEW REF!
THEN ENTER
TO START GPS

12. Repeat point 4., 5., 6. and 7. to store next target.

DME BASELINE

DME BASELINE is only available for the VL GEO. Ultrasound can be used instead of laser to measure a point on the baseline of the object in case e.g. part of the baseline is covered by vegetation.

Make sure that the T3 transponder is turned on. Stand on the reference point and aim at the T3 transponder and press ON to measure distance and angle to the transponder. Aim at the transponder until a beep goes off and a result is shown in the heads-up display. You can also activate ultrasound measurement if laser is used by pressing a long press on the DME button. A short press on DME will change the Laser mode.

This function uses **EYE HGT** and **TRP.HGT** to calculate the height to ground level. The T3 transponder can therefore be positioned above the ground. Make sure that correct **TRP.HGT** is set in SETTINGS menu. If the transponder is placed on the ground set TRP.HGT to zero (0). Default TRP.HGT is 1.3m (4.3ft).

Ultrasound can also be used when moving to a new reference point. Select option **USE DME** in the NEW REF. menu. The procedure is the same as when you measure a point on the baseline.

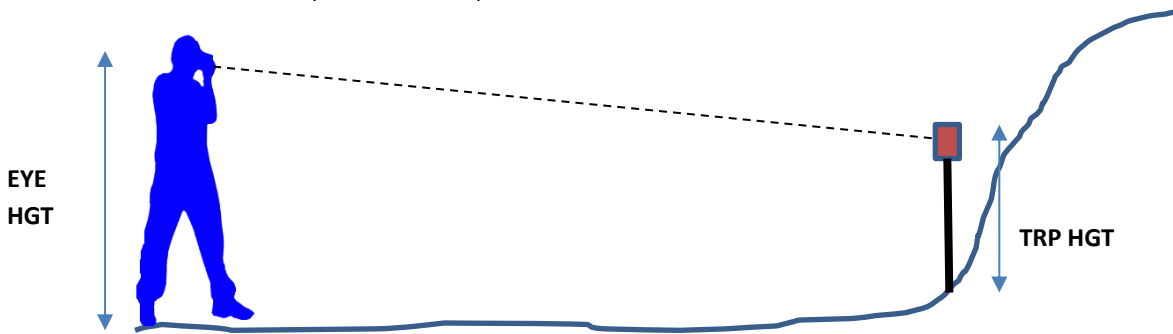

TARGET SUMMARY

The total area and the horizontal circumference are shown in the last screen. Note that this data assumes that an area has been measured. If 3D target is measured, these data should be ignored.

AREA
58 m²
LENGTH
45 m

TARGET CSV DATA

Target data is available in the instrument in library **VL_GEO:\DATA** or **L_GEO:\DATA**.

1. Press ON to start the instrument.
2. Connect your computer and the instrument with a mini USB cable.
3. Your Target data is found in the file MAPXXX.CSV (csv file) and in MAPXXX.KML (Google Earth file) where XXX is the ID for the Target.
4. Copy/move your files to your computer for backup and use your favorite spreadsheet or GIS software to open your data files. The KML file can be opened straight in Google Earth.

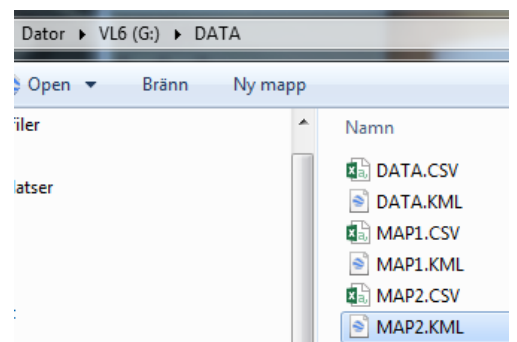

EXAMPLE GOOGLE EARTH FILE, KML FILE

The first example below shows target data from two different reference points. Each target position in the KML file is defined as "PXXX,Y" where 'XXX' is the Target ID and 'Y' is the measuring sequence. The KML file can be opened in Google Earth for a visual data quality check. The second example shows a 3D target with Target data from three different reference points.

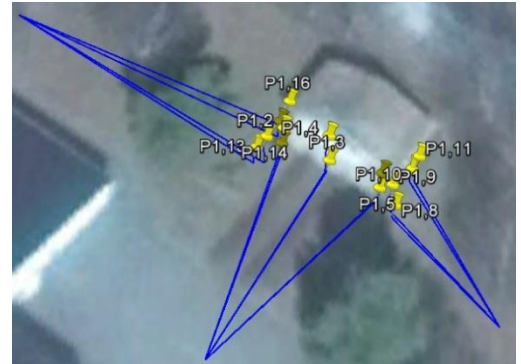
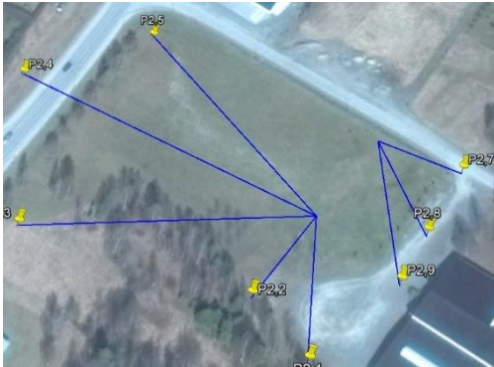

TO EVALUATE MAP TARGET DATA

Haglöf Sweden provides freeware for Windows, HeapCalcVol.exe. This application evaluates the target data file and estimates the total area and volume for an area or a heap. HeapCalcVol is available in English and can be downloaded from www.haglofsweden.com.

The screenshot shows the HeapCalcVol application window. On the left is a 'REPORT' section with input fields for Object, User, and Comments, and a Date field set to 2017-07-25. Below this is a list of file and target data:

File	LARGEHEAP.csv
Geo Snr	51999
Geo Ver	10
ID	2
Lat	N63.1781820
Lon	E17.0707845
Volume adjustment factor	1.0

Below the report is a 'RESULT' section:

Number of measurements	1646
Volume	5325 m3
Base area	2258.0 m2
Periphery	189 m
Average height	2.4 m
Slope angle	0.0 ° (0.0 %)

On the right side of the window are three 3D plots. The top plot shows a top-down view of the target area with blue bars representing 'Ref' (reference) points and black dots representing 'Base' points. The middle plot shows a side view of the target area with red bars representing the height of the target. The bottom plot shows a side view of the target area with red dots representing the height of the target.

MAP GPS

In MAP GPS a GPS coordinate is collected for each new target point instead of using reference points. For best precision, connect a sub meter GPS to the GEO instrument.

1. Press ON to start the GEO instrument.
2. Select menu **MAP TARGET/MAP GPS** from the main menu and press ON button.

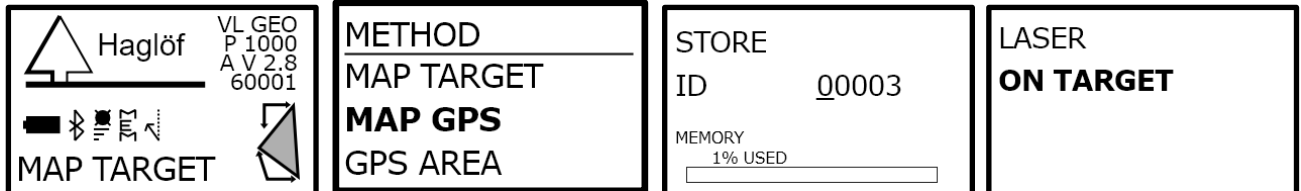

3. Enter an ID for your target. This ID is used to name the data files. Use the Send button to move the cursor and the DME button to change the digit ('0'-'9') at the cursor position. Press ON to store the ID. Note! if entering an already existing ID, data will be added continuously to the object that is being measured.
4. The Instrument is now ready for the first target. Press ON to go to the measuring menu.
5. Aim and press ON to measure with laser. Keep the instrument still until a signal is heard and a result is displayed. If the target data seems reasonable and the laser has hit the target, press **SEND** to store the target data. If not, re-measure the target.
6. The GPS will automatically start when you store the first target, to map your position. On the first target you need to store the GPS position by pressing the ON button, but on following targets the position will be stored automatically. GPS coordinates is averaged until you press ON. The averaging can be zeroed by pressing DME button.
7. Repeat point 5 for your next target.



8. Press Exit and select **FINISH** to finalize the mapping.

TARGET CSV DATA

Target data is available in the instrument in library **VL_GEO:\DATA** or **L_GEO:\DATA**.

1. Press ON to start the instrument.
2. Connect your computer and the instrument with a mini USB cable.
3. Your Target data is found in the file MAPGPSXXXX.CSV (csv file) and in MAPGPSXXX.KML (Google Earth file) where XXX is the ID for the Target.
4. Copy/move your files to your computer for backup and use your favorite spreadsheet or GIS software to open your data files. The KML file can be opened straight in Google Earth.

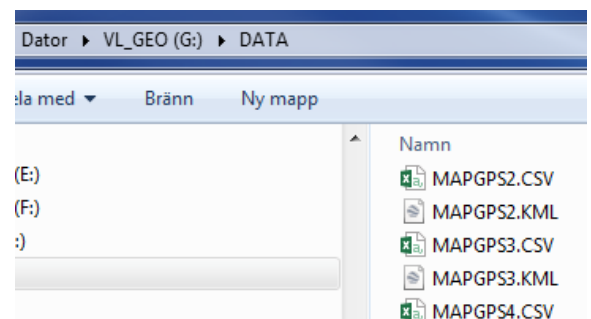

EXAMPLE GOOGLE EARTH FILE, KML FILE

Each target position in the KML file is defined as “PXXX,Y” where ‘XXX’ is the Target ID and ‘Y’ is the measuring sequence. The KML file can be opened in Google Earth for a visual data quality check.

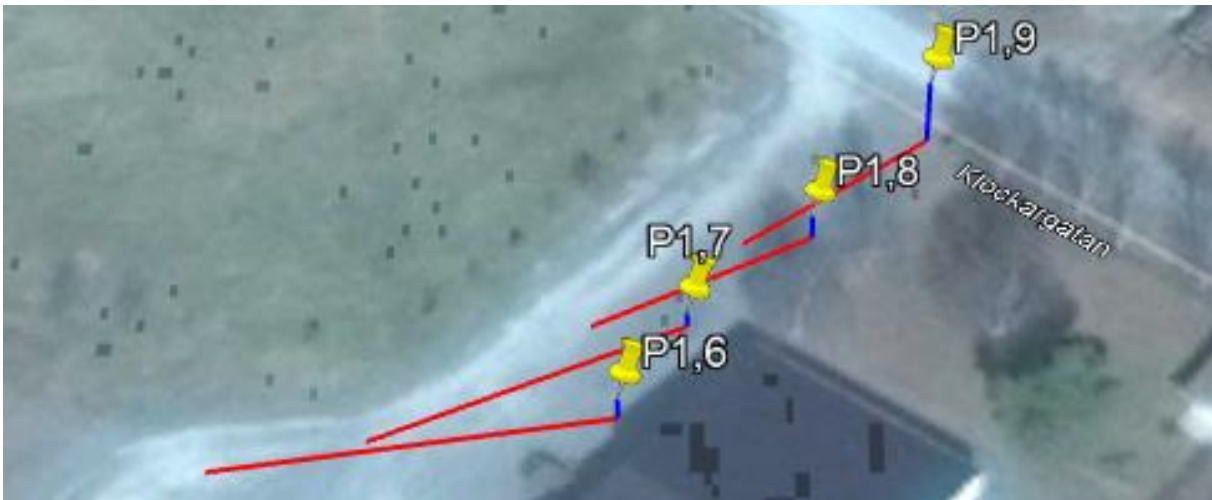

COMPASS

COMPASS FUNCTION IN THE GEO INSTRUMENT

Be aware that the expected azimuth error is around 1.5° RMSE. This is close to 3m/3yrd at 100m/100yrd. The error can be greater if magnetic objects are closer than 1-2m from the GEO instrument. The internal compass is sensitive to external factors, such as environmental changes, close-by objects such as mobile phones and handheld computers, and if the user is wearing metal-framed eye glasses. If using a monopod with the GEO instrument, make sure it is a non-magnetic monopod. A custom-built, non-magnetic monopod is available as an accessory to the GEO instrument package.

USING THE COMPASS

The COMPASS function shows the azimuth continuously and simultaneously, in the heads-up display and the external LCD display. The heads-up display shows the azimuth without decimal.

1. Press ON to start the GEO instrument.
2. Select **COMPASS** from the main menu and press the ON button.

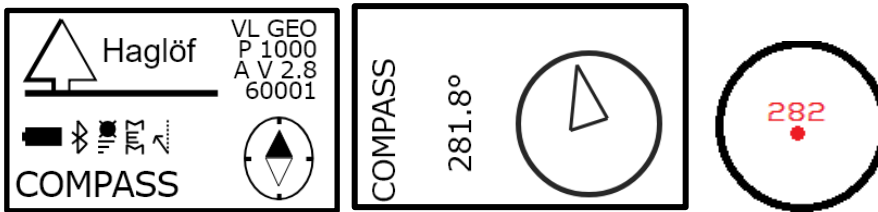

3. **Laser:** Press the ON button to measure azimuth, pitch and distance (laser) to a target.
or
DME: Press the DME button to measure compass direction, angle and distance (ultrasound) to the transponder.
Make sure to place the transponder at the correct height (**TRP.HGT**).

- a. **SD** Slope Distance (m or feet)
- b. **HD** Horizontal Distance (m or feet)
- c. **H** Height (m or feet)
- d. **DEG** Angle (Degree, % or Grads)
- e. **AZ** Azimuth (Degree or Grads)

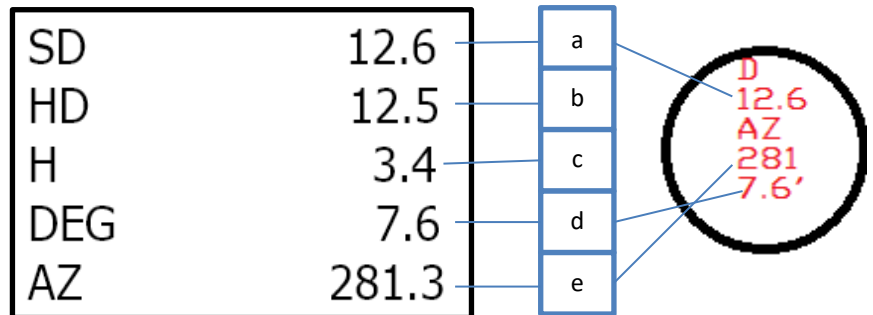

3D VECTOR

The 3D vector function calculates the distance, angle and azimuth between two points. This implies that 3D data can be measured from a remote distance. This is very useful to measure objects such as canopy width or remote slope determination.

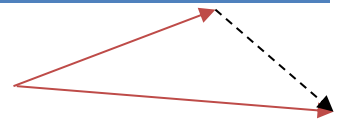

EXAMPLES

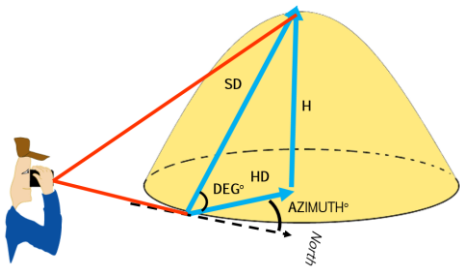

Measuring pile height.

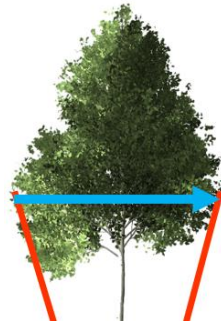

Measuring canopy width.

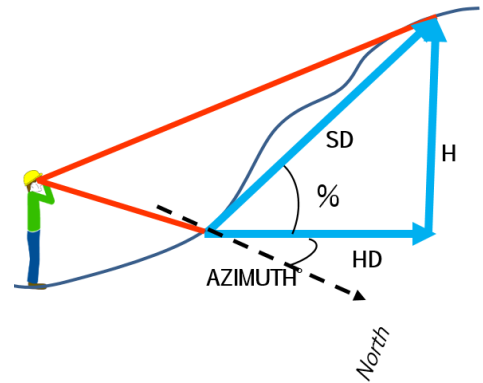

Measuring slopes.

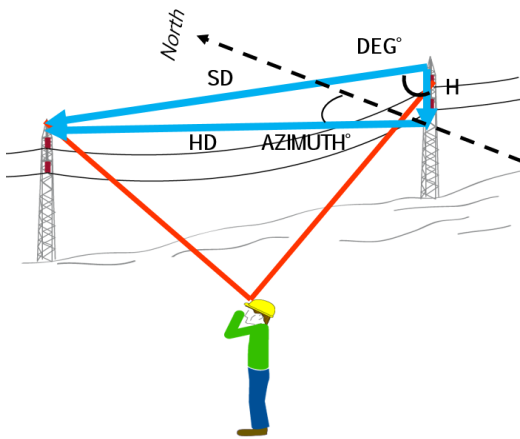

Measuring distance between power line poles.

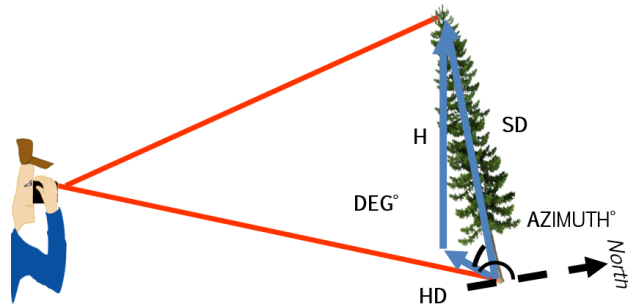

Measuring length (SD) of a leaning tree.

1. Press ON to start the GEO instrument.
2. Select **3D VECTOR** from the main menu and press the ON button.

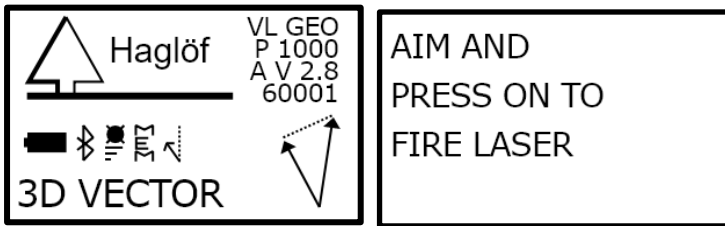

3. Point 1: Aim and press ON to measure with laser. Keep the instrument still until a signal is heard and a result is shown in the heads-up display. If target data is reasonable and the laser has hit the target, press **SEND** to accept this target data. If not, re-measure the target.

- a. **SD** Slope Distance (m or feet)
- b. **HD** Horizontal Distance (m or feet)
- c. **H** Height (m or feet)
- d. **DEG** Angle (Degree, % or Grads)
- e. **AZ** Azimuth (Degree or Grads)

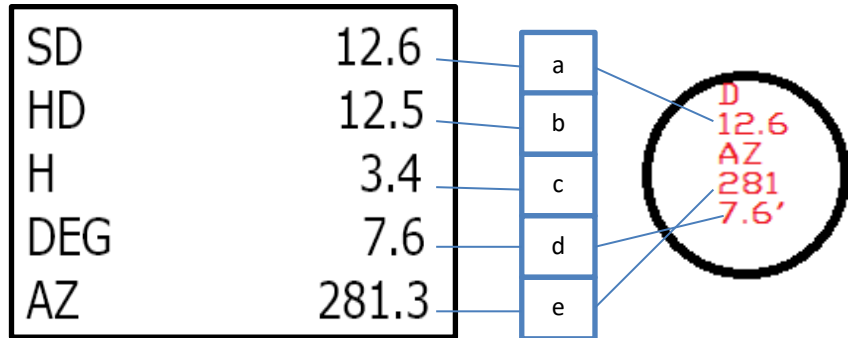

4. Point 2: Repeat 3. to measure point 2.
5. When point 2 is accepted (press the **SEND** button), the total vector result between point 1 and point 2 is displayed.

SD	7.1
HD	5.4
H	4.6
DEG	40.5
AZ	112.4

ANGLE– MEASURING OF ANGLES/INCLINATION

Angle measuring can be used to measure e.g. inclination in slopes.

1. Press ON to activate the instrument.
2. Select ANGLE and press ON to confirm this selection.
3. Aim and keep pressing ON until a short beep is heard and a result is shown in the heads-up display.
4. The angle to the target is shown in the display.

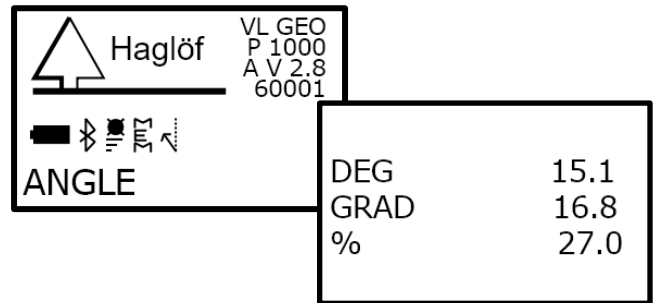

Press both DME and SEND buttons to step out of menu.

ANGLE – HORIZONTAL DISTANCE WITH ULTRASOUND WITH THE VERTEX LASER GEO

1. Make sure that the VERTEX LASER GEO instrument is turned off.
2. Start the T3 transponder by holding the ultrasonic transceiver on the VERTEX LASER GEO instrument close to the center of the transponder and pressing DME. Await two (2) short beeps from the transponder. The T3 transponder is now turned on and will remain active in ON mode until turned off. The T3 transponder is automatically turned off after approx. 20 minutes inactivity (battery saving function). To turn the T3 transponder off (OFF), repeat the procedure and wait for four (4) beep signals.
3. Press both DME and SEND buttons to turn the instrument off.
4. Press ON to activate the instrument.
5. Select ANGLE and press ON to confirm the selection.
6. Aim and press ON until a short beep is heard and a result is shown in the display.
7. Press DME to measure the distance.
8. Read the horizontal distance result in the display.

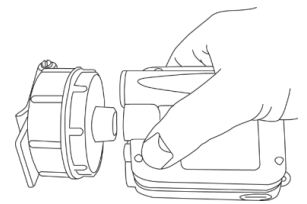

Press both DME and SEND buttons to step out of menu.

LINE CLEAR

The GEO instruments include functions to calculate the minimum theoretical distance from the top of a tree to a power line, a road or other object. The risks that a falling tree could cause damage can be calculated with a margin value that is featured in the instrument display. The functions are called **LINE CLEAR** and **MIN. DIST.** Note! it is always recommended to work with a security margin. Factors of uncertainty can affect the measurement results. Some calculations are based on the presupposition that an object, for example a tree, is standing completely straight when you measure its height. A tree that is leaning in the opposite direction from the user's position will obtain a lower height value. Other factors that may affect the results are air temperature and power output in a power line that may extend or shrink the power line. If you are not sure that the laser beam has hit the right spot/target object, it is recommended to perform several measurement operations for the object.

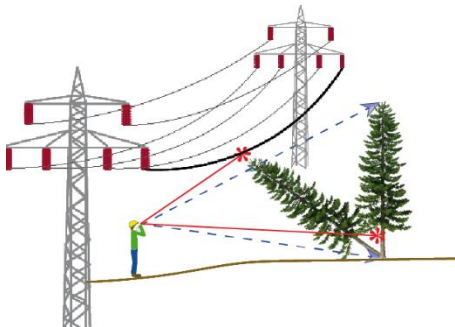
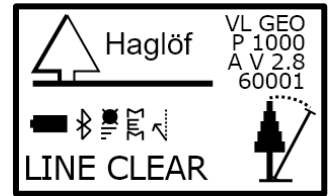

Will the tree top hit the powerline if it falls?

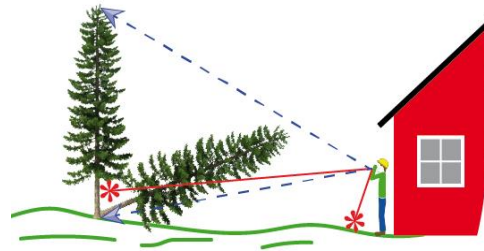

Will the tree top hit the house if it falls?

POWER LINE EXAMPLE

STEP 1

Stand behind a power line to measure the height of the line and for the targeted tree. The result will be independent of your current ground level position. It is important that you are standing aligned to the point you are aiming at on the power line and the tree.

1. Stand at a distance from the line and centered to the line and the tree. The recommended minimum distance is 10m/32.8ft when the line height is 10m/32.8ft.
2. Press ON to activate the instrument.
3. Select **LINE CLEAR / LINE CLEAR** and press ON to confirm.
4. When the red dot sight is turned on and the text **AIM AND PRESS ON TO FIRE LASER** is shown in the display, aim at the line and give a short press at ON to measure the distance. Aim at the line until a short beep is heard and a result is displayed. If necessary, press the DME key to temporarily change Laser mode (First-, Strongest-, Last- target) allowing the laser to work in optimal mode for the current situation, for example use **First** mode to avoid the laser to hit a second target behind your target.
5. To re-measure, aim at the line again and press ON briefly. Repeat if needed.
6. Accept the height value with the SEND button.

Distance and height to the tree are measured with laser (VERTEX LASER GEO: or with ultrasound and the transponder T3):

STEP 2: 3-POINT MEASURING WITH LASER

1. When the red dot sight is turned on and the text **AIM AND PRESS ON TO FIRE LASER OR PRESS DME** is shown in the display, aim at chosen reference point on the target object, preferably a point free from branches (if target object is a tree). Give a short press at ON to measure distance and angle to the point. Aim at the point until a short beep is heard and a result is displayed. The display will feature the height to the reference point calculated from the pre-set eye

height (EYE HGT in the SETTINGS menu). If your object is covered by vegetation or branches, you can measure the distance and the angle to the top of the object instead. This point may however give uncertain results if the top has/is a broad/wide and diffuse crown. If necessary, press the DME key to temporarily change your Laser mode (First-, Strongest-, Last- target) to allow the laser to work in optimal mode for the situation. Use for example **Last** mode to avoid the laser beam to hit smaller objects in front of the target such as grass or bushes. The distance and the angle can be re-measured if aiming at the reference point again and giving a short press at ON.

2. Aim at the tree base or other reference point on the object. Press ON and keep pressed until a beep is heard and the red dot sight blinks briefly. Release the button.
3. Aim at the top of the object and keep ON pressed until the beep is heard.
4. Press any button to move forward.
5. The Instrument will calculate the difference and display **OK** or **NOT OK**. The tree height and the horizontal distance between the tree and the power line are also displayed.

- a. **H** Height (m or feet)
- b. **HD** Horizontal Distance (m or feet)
- c. **DIFF: OK** 1.2M (1.2M margin)
Example showing a difference/safety margin of 1.2m.

H	16.8
HD	18.0
DIFF: OK	1.2 M

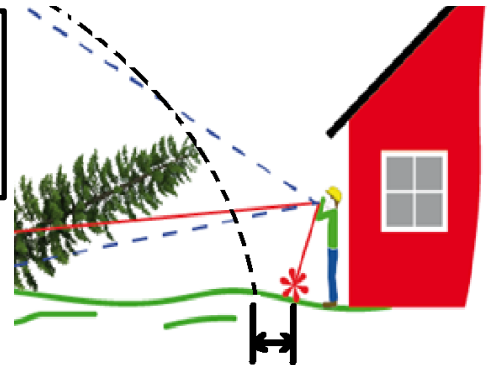

6. Press ON to measure another tree height.
7. Press both DME and SEND buttons to step out of menu.

STEP 2: 2-POINT MEASURING WITH ULTRASOUND IN THE VERTEX LASER GEO

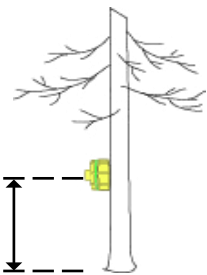

1. Turn on the T3 transponder and place at the correct current height (**TRP.HGT** in the **SETTINGS** menu). Make sure that the ultrasound has been calibrated and adjusted to current air temperature.
2. When the aim point is turned on and the text **AIM AND PRESS ON TO FIRE LASER OR PRESS DME** is displayed, aim at the transponder T3 and give a long press on DME to measure the distance and the angle to the transponder. Aim at the transponder T3 until a beep is heard and a result is shown in the display.
3. Aim at the top of the object and press ON until the beep is heard.
4. Press any button to step forward.
5. The Instrument calculates the difference and if **OK** or **NOT OK**. The tree height (**TRP HGT** included) and the horizontal distance between tree and power line are displayed.
6. Press ON to measure another tree height (move the T3 transponder) or repeat at the same tree.
7. Press both DME and SEND buttons to step out of menu.

MIN. DIST.

The MIN. DIST. function can be used to calculate the minimum distance from for example a tree branch or a tree top to a power line. The function is especially useful in situations when it is difficult to find a good position to make the measurement, because of native vegetation and the profile of the terrain. In those situations, it is sometimes very hard to determinate where you should aim on the power line in order to really measure the shortest distance from the branch to the power line.

Measure instead two points on the power line and the instrument will calculate a straight line between the points. Then measure on the tree and the instrument will calculate the shortest distance from the tree to the imagined line.

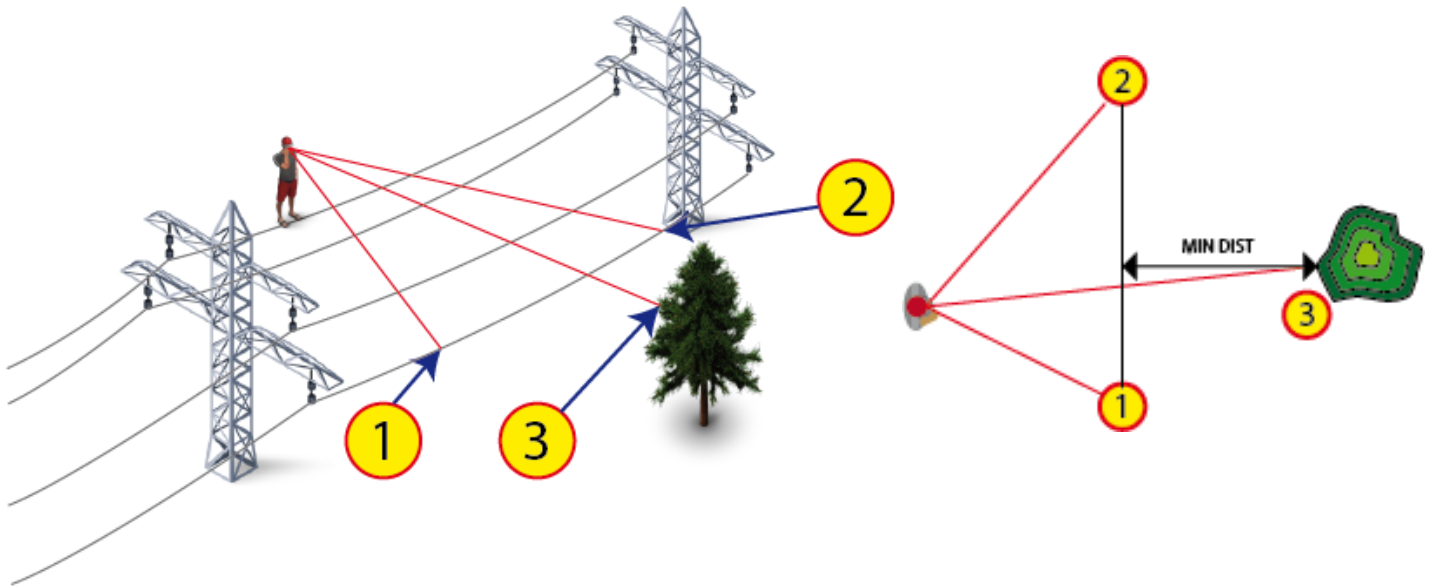

STEP1 – FIRST POINT ON THE POWERLINE

1. Stand at a distance from the line. The recommended minimum distance is 10m/32.8ft when the line height is 10m/32.8ft.
2. Press ON to activate the instrument.
3. Select **LINE CLEAR / MIN.DIST.** and press ON to confirm.
4. When the red dot sight is turned on and you see the text **P 1** and the text **AIM AND PRESS ON TO FIRE LASER** is shown in the display, aim at the line and give a short press at ON to measure distance and angle to the first point on the line. Aim at the line until a short beep is heard and a result is displayed. If necessary, press the DME key to temporarily change Laser mode (First-, Strongest-, Last- target) allowing the laser to work in optimal mode for the current situation, for example use **First** mode to avoid the laser to hit a second target behind your target.
5. To re-measure, aim at the line again and press ON. Repeat if needed.
6. Accept the height value with the SEND button.

STEP2 – SECOND POINT ON THE POWERLINE

1. When the red dot sight is turned on and you see the text **P 2** and the text **AIM AND PRESS ON TO FIRE LASER** is shown in the display, aim at the line and give a short press at ON to measure distance and angle to the second point on the line. Aim at the line until a short beep is heard and a result is displayed
2. To re-measure, aim at the line again and press ON briefly. Repeat if needed.
3. Accept the height value with the SEND button.

STEP3 – THIRD POINT ON THE OBJECT

1. When the red dot sight is turned on and you see the text **P 3** and the text **AIM AND PRESS ON TO FIRE LASER** is shown in the display, aim at the part of the tree, or other object, that you like to know the minimum distance to and give a short press at ON to measure distance and angle to that point. Aim at the point until a short beep is heard and a result is displayed
2. To re-measure, aim at the point again and press ON briefly. Repeat if needed.
3. Accept the height value with the SEND button.

RESULT

The program will now calculate the minimum distance from point 3 to the imagined line between point 1 and 2.

- a. **DIST** minimum distance (m or feet)
- b. **PITCH** angle from point 3 to the line between point 1 and 2 (Degree, % or Grads)

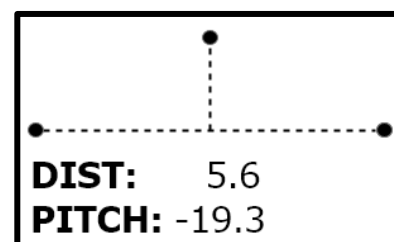

DELTA HGT

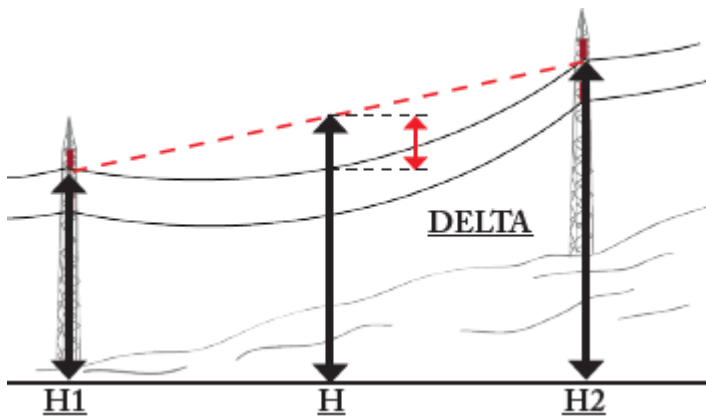

DELTA HEIGHT FUNCTION

The Delta Height function is used to estimate the height difference between a point on an imagined straight line between two (2) fixed positions and a third point, for example a power line, where the line sag is the closest to ground level.

1. Go to the place where the line sag is the closest to ground level.
2. Press ON to activate the instrument.
3. Select **DELTA HGT** and press ON to confirm this selection.

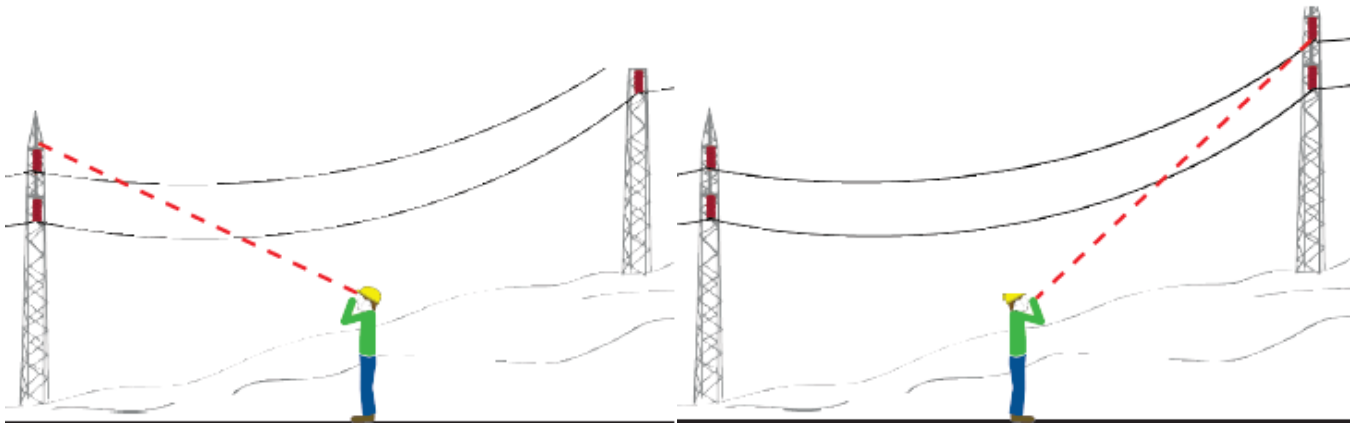
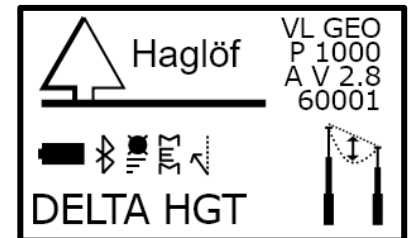

4. Aim at the H1 point on the target and give a short press at ON to measure the distance and angle. Aim until a short beep is heard and the red dot sight blinks briefly. Re-measure the value by giving another short press at ON or approve by moving forward with SEND.
5. Aim at the H2 point and give a short press at ON to measure the distance and angle. Aim until a short beep is heard and the red dot sight goes out. Re-measure the value by giving another short press at ON or approve by moving forward with SEND.
6. DIFF is now shown in the display, i.e. the difference between H1 and H2.

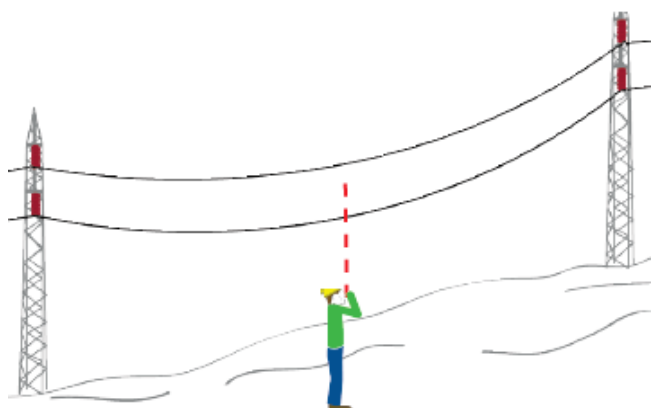

HD1	24.4
HD2	23.6
H 15.6	16.8
DELTAH	1.5

7. Accept the distance and height to H1 and H2 with a short press at ON, DME or SEND. The red dot sight will light up again. Re-measure the value by giving another short press at ON or approve by moving forward with SEND.

8. Aim at the line and give a short press at ON to get the distance and angle. Aim until a short beep is heard and the red dot sight goes out. The Delta Height (DELTAH) is shown in the display. Press DME and SEND simultaneously to step out of the menu.

DME – DISTANCE MEASURING WITH ULTRASOUND VERTEX LASER GEO

1. Turn the VERTEX LASER GEO off (OFF).

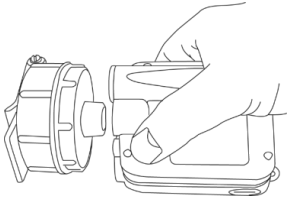

2. Start the T3 transponder by holding the ultrasonic transceiver on the VERTEX LASER GEO instrument close to the center of the transponder and press the DME button on the VERTEX LASER GEO. Wait for two short beeps from the transponder. The T3 transponder is now ON and will stay ON until turned off or after approx. 20 minutes of inactivity when it automatically turns off. To turn the T3 transponder off (OFF), repeat the procedure described above and wait for four (4) short beeps.

The T3 transponder can be placed on the monopod staff in the center of a plot (distance up to 20 meters or better) or pinned to a tree stem (distance 30 meters or better).

3. Press the DME button to measure the distance to the transponder. The result is presented in the display. If the BAF function is activated, the Ø min diameter is calculated and shown (pic 2). Note you can also use the laser in this menu, aim and press ON to measure with laser.

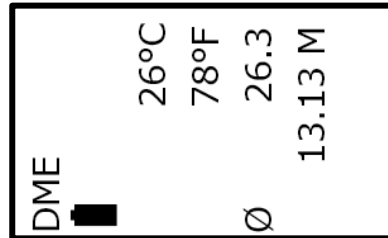
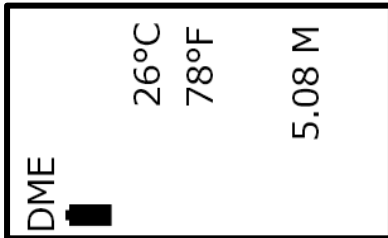

4. Repeat point 3 to measure more distances.

Press both the DME and SEND buttons to turn the VERTEX LASER GEO instrument off.

Ultrasonic pulses travel with different speed depending on weather circumstances, air pressure and other. In open terrain and without obstacles between the instrument and the transponder, distances up to 40 meters can sometimes be measured with ultrasound and the T3 transponder.

The ultrasound must be calibrated in ambient temperature. The VERTEX LASER GEO must maintain the same temperature as the air. A built-in sensor will compensate for changes in the temperature. To obtain best possible measuring precision it is recommended to check and, if necessary, calibrate the instrument on a regular basis, and preferably daily.

CALIBRATE – CALIBRATING THE ULTRASOUND

To obtain maximum level of accuracy in the ultrasound measuring, the VERTEX LASER GEO instrument needs to be calibrated.

1. Make sure that the instrument has ambient temperature – not colder and not warmer.
2. Measure the exact distance of 10m/32.8 feet with a tape or similar.

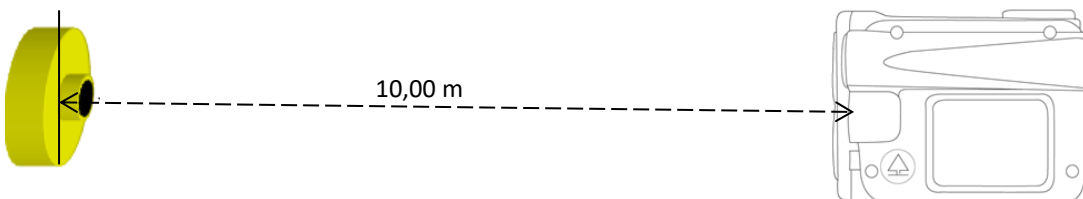

3. Place the T3 transponder at the finish of the exact 10m distance.
4. Make sure that the VERTEX LASER GEO is turned off (OFF).
5. Start the T3 transponder by holding the ultrasonic transceiver on the VERTEX LASER GEO close to the center of the transponder and press DME. Wait for two (2) short beep signals from the transponder. The T3 transponder is now

turned on and will be in ON mode until turned off or after approx. 20 minutes of inactivity when it automatically turns off. To turn the transponder OFF, repeat the procedure and wait for four (4) short beep signals.

6. Press both DME and SEND buttons to turn off the VERTEX LASER GEO instrument.
7. Go to the zero point for the measured distance and aim the front of the VERTEX LASER GEO instrument to the transponder.
8. Press ON to activate the instrument.
9. Select **SETTINGS** and **CALIBR. DME** and press ON to confirm.

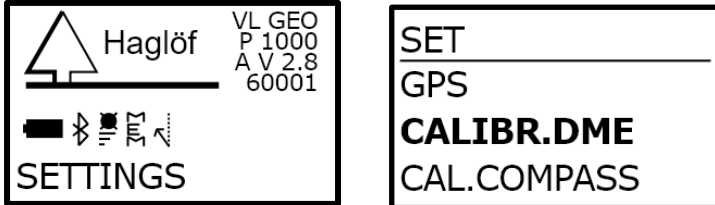

10. When the digits 10.00 are shown in the display, the calibration of the VERTEX LASER GEO ultrasound is ready.

Press both DME and SEND buttons to step out of the menu.

It is important that the temperature sensor is given enough time to correctly determine the ambient temperature. If you are carrying the instrument in your pocket, you might have to allow up to 10 minutes before accurate measurement results can be obtained.

If the VERTEX LASER GEO is in a pocket with a temperature of +15C and the outside temperature is at -5C, the measuring result will be 10.40m instead of the correct 10,00m. The temperature pending measuring fault at 10.0m is approx. 2cm/°C.

The error will decrease rapidly, but the final accuracy might take up to 10 minutes to achieve. Taking this into account, calibrating the instrument before the sensor has had time to stabilize will make the error permanent. The display will show the correct result for a short while, but a few minutes later, the result will be inaccurate.

BAF – BASAL AREA FUNCTION

When working with the relascope method and prisms, some trees can be covered by other trees, and a correct evaluation of the basal area is prevented. The VERTEX LASER GEO has a built-in BAF function where the minimum diameter is shown when measuring the distance to the tree from the reference point with ultrasound. Start with setting up the factor (BAF) for the prism or relascope in the **SETTINGS** menu, (see section **SETTINGS** in this user's guide). Measure the distance from the tree to the reference point with the VERTEX LASER GEO DME function. The distance and minimum diameter as calculated (cm/inch) are featured in the display. The tree diameter is measured and only added in the plot if its diameter exceeds or equal the value shown in the display.

In leaning (inclining) terrain, the VERTEX LASER GEO can compensate for the inclination and calculate the diameter measure. In such cases, use the ANGLE function in the menu to measure the distance and angle from the tree to the reference point (see section ANGLE in this user's guide).

BAF WITH LASER

You can also use the laser function to measure the distance and calculate the minimum diameter. Aim and press ON to measure the distance. The BAF function using laser technique is available in the VERTEX LASER GEO and LASER GEO.

GPS

Your measuring data can be tagged with coordinates from the GEO instrument’s built-in GPS. It is also possible to use an external Bluetooth GPS receiver, such as the Geode or the Trimble R1, to obtain sub meter accuracy. When using GPS, your data can also be used in a GIS software such as Google Earth or similar. For higher accuracy and before storing any data with coordinates, allow at least 10minutes after powering up the instrument for the GPS units to stabilize before starting to use the GPS function.

The internal GPS has a 33-channels, high sensitivity GPS receiver that simultaneously supports several common satellite systems such as GPS, Glonass, Galileo and GZSS. The GPS can use different systems at the same time, and this highly improves positioning in dense terrain. It includes built-in, real-time correction, free of charge, with SBAS (EGNOS, WAAS, MSAS, GAGAN) that enables precision down to 2.5m CEP in open terrain. The GPS can quickly locate satellites through built-in algorithms that predict satellite positions for up to three days. The algorithms use data from the last satellite constellations that are saved in the Instrument (provided that the battery has power).

GPS USE

TURN ON THE GPS

1. Press ON to start the GEO instrument.
2. Select **SETTINGS** in the main menu, followed by menu **GPS**. Press the ON button.

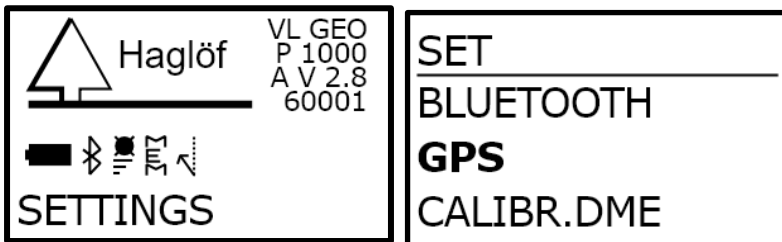

3. Use the DME- or SEND button to tick the **USE GPS** box, then press ON to move on. Note that the Instrument will remember this option, also if the instrument is turned off. The auto turn-off feature in the Instrument is delayed with 18 minutes when the GPS is activated, to ensure GPS accuracy.

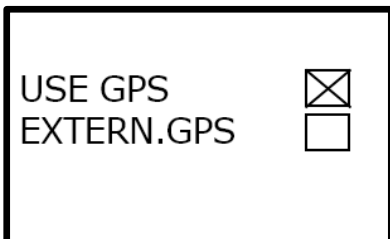

4. If using an external Bluetooth GPS receiver, tick the **EXTERN.GPS** box. The Geo will ask for a pin code if this is needed to pair the instrument to the external GPS (see documentation for the GPS for details). The Geo Instrument will search for available devices, and it is important to turn on the external GPS before this search starts. When the search is finished, choose your device from the list and Press Enter to connect.



USE AS EXTERNAL GPS

The GEO instrument can also be used as an external GPS and send GPS data to another unit.

1. Press ON to start the GEO instrument.
2. Activate Bluetooth (select **SETTINGS** in the main menu and then **BLUETOOTH**) and let the unit, that is going to receive the GSP coordinates, connect to the GEO instrument.
3. Select **SETTINGS** in the main menu, followed by menu **GPS**. Press the ON button.



4. Use the DME- or SEND button to tick the **USE GPS** box, then press ON to move on.

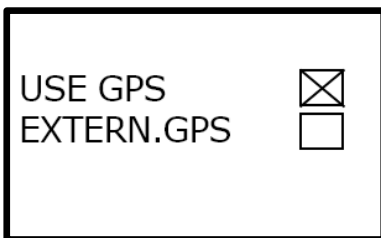

5. Let the **EXTERN.GPS** box be unchecked and press ON. The GEO instrument will now start to send GPS data.

GPS FIX

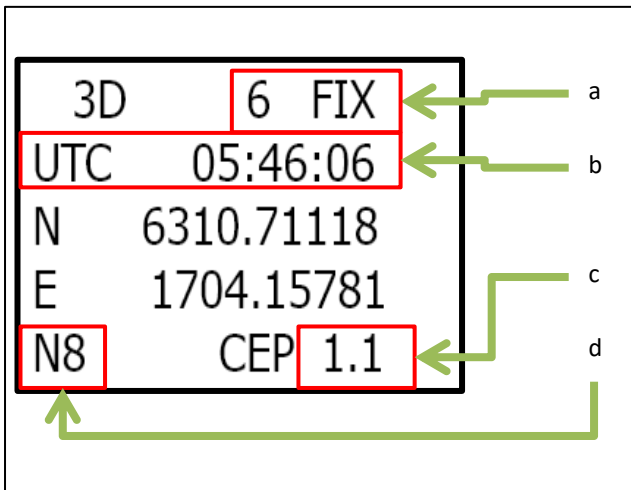

- a. Number of satellites
- b. Utc time
- c. CEP error (m)
- d. Number of samples

Depending on time elapsed since last use and location for the GPS, the GPS module will need some time to determine its first position – its fix. A fix is normally obtained within a couple of minutes. For a quicker fix, an open, unobstructed sky is necessary. For increased accuracy, allow the GPS approx. 10 minutes of activity after the first fix.

STORE A SINGLE COORDINATE

Use the GPS menu to store a coordinate.

1. Press ON to start the GEO instrument.
2. Select **SETTINGS** from the main menu and menu **GPS**. Press the ON button.
3. Use the DME- or SEND button to tick the “**USE GPS**” box, then press ON to continue.
4. Press the SEND button when you have a fix (see above, “GPS Fix”). Enter an ID and press the ON button. The coordinate will be stored in the data files **DATA.CSV** and **DATA.KML** in library **VL_GEO:\DATA** or **L_GEO:\DATA**.

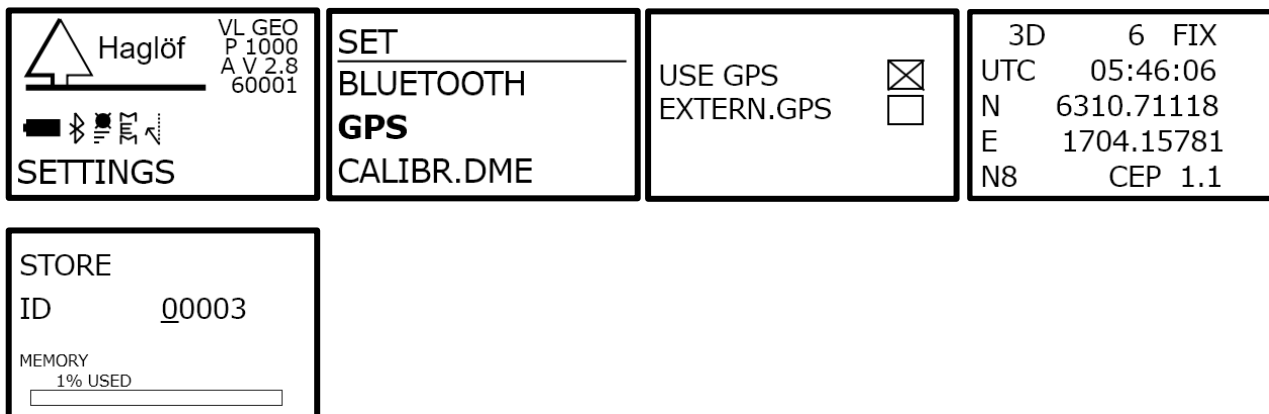

USE GPS TO MEASURE AREA

The Geo instrument has a feature for measuring an area with the built-in GPS or with an external Bluetooth GPS. The result can be seen directly in the GEO instrument after completion of the measurements. Data from the measurements are stores in a csv and google earth file if later processing is needed.



Start from a position and then walk around the area to be measured. GPS positions are automatically stored every 5 meters. You can also store manually selected GPS positions by pressing ON. Finish the measurement by pressing DME and SEND at the same time when you are a couple of meters from your starting point.



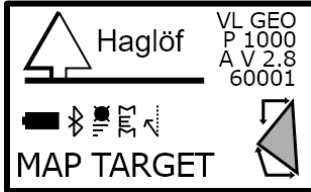

1. Press ON to start the GEO instrument.
2. Select the **MAP TARGET / GPS AREA** menu from the main menu and press the ON button.
3. Enter an ID for the area. This ID is used to name the data files. Use the SEND button to move the cursor and the DME button to change the number ('0' - '9') at the cursor position. Press ON to store ID. Note! If you enter an existing ID, data will continuously be added to the existing inventory.
4. The GEO instrument is now ready to start logging GPS positions. Press ON when you are in your starting position.
5. Start walking around the area to be measured. The GEO beeps for each new stored position (approximately every 5 meters). You may also add extra coordinates by pressing ON.
6. Exit the measurement by pressing DME and SEND simultaneously when you are about 5-10m from your starting position.
7. The result is displayed in m² / ha respective m or ft² / ac and ft depending on the device setting in Geo is Metric (Metric) or Imperial (FEET).

 <p>MAP TARGET</p>	<p>METHOD MAP GPS GPS AREA EXIT</p>	<p>STORE ID 00003 MEMORY 1% USED</p>	<p>LOG START [ENTER]</p>
<p>3D 6 FIX UTC 05:46:06 N 6310.71118 E 1704.15781 N8 CEP 1.1</p>	<p>AREA 2598 m2 LENGTH 224 m</p>		

GPS DATA

Gps data is available in the instrument under the **VL_GEO: \ DATA** or **L_GEO: \ DATA** library

1. Press ON to start the instrument.
2. Connect your instrument to your computer with a mini USB cable.
3. Data is found in the GPSXXXX.CSV file (csv file) and in GPSXXX.KML (Google Earth file) where XXX is the ID of the object.
4. Copy / Move your files to your computer as backup and use your favorite calculator or GIS software to open your data files. The .kml file can be opened directly in Google Earth.

 DATA.CSV	Microsoft Excel-fil...	1 kB
 DATA.KML	KML	1 kB
 GPS1.CSV	2018-01-10 08:54 Microsoft Excel-fil...	4 kB
 GPS1.KML	2018-01-10 08:54 KML	2 kB

EXAMPLES OF GOOGLE EARTH FILE, (KML FILE)

Below is an example of a KML file opened in Google Earth.

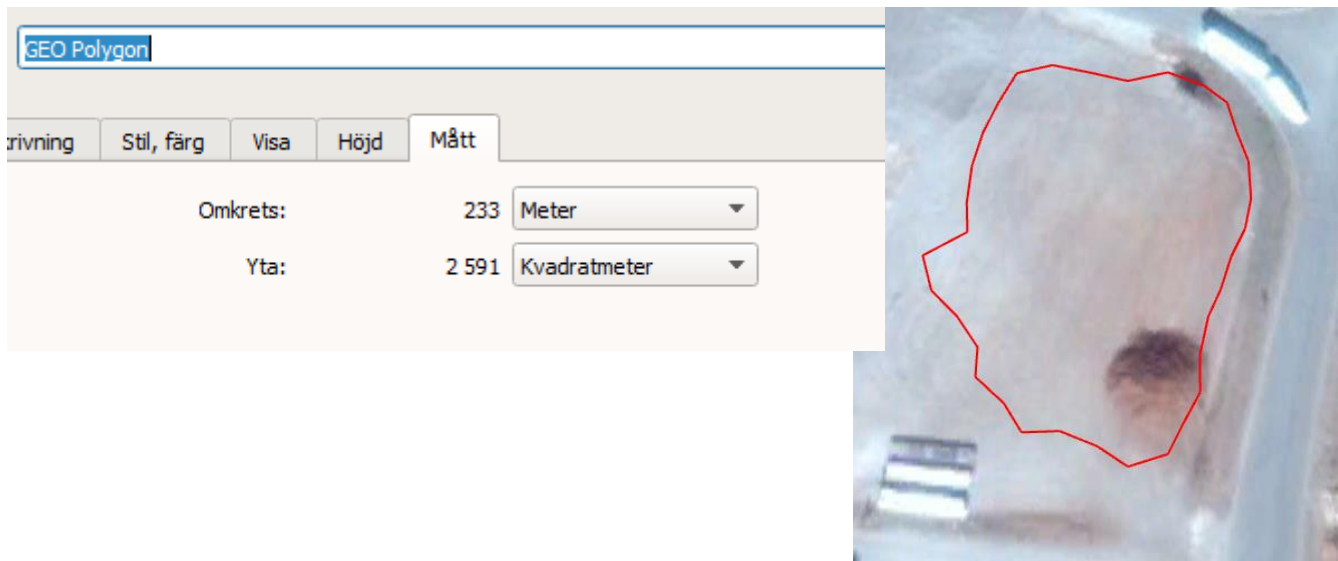

CONTRAST – SETTINGS OF DISPLAY CONTRAST

1. Press ON to activate the instrument.
2. Select **SETTINGS** in the main menu and go to menu **CONTRAST**. Press ON button.

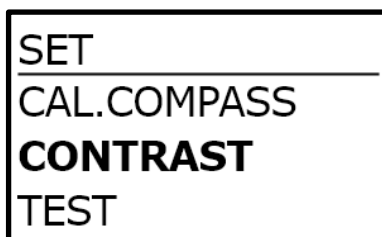
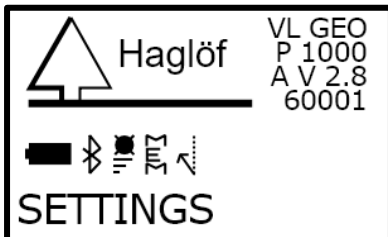

3. Use the DME and SEND buttons to change the display contrast. There are 24 different positions for the contrast.
4. Press ON to confirm or press both DME and SEND to leave this function and menu.

MEMORY FUNCTIONS

The Instrument has a built-in SSD drive to save data and results. Data is saved by pressing the SEND button, provided that the saving function has been activated in the MEMORY menu. About 2000 measuring operations can be stored in the memory. When a measurement is stored, the text **DATA SAVED** is shown in the display. A measurement can only be stored once.

ENABLE MEMORY

Enable the built-in memory to store results when pressing the SEND button. Note: When activating the memory function, the ability to send data via Bluetooth or IR is disabled

1. Press ON to activate the instrument.
2. Select **SETTINGS** from the main menu and go to menu **MEMORY**. Press ON button.

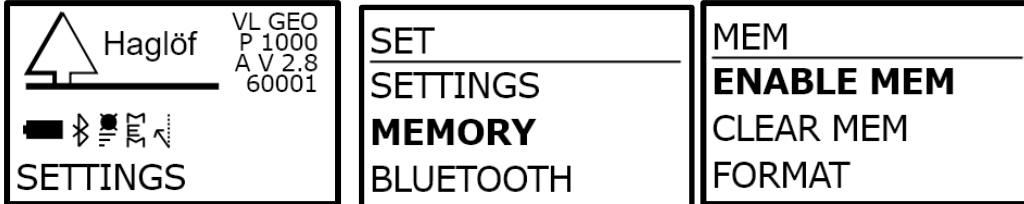

4. Select **ENABLE MEM** and press ON to confirm this selection.
5. Use DME- or SEND button to tick the **MEMORY** box, then press ON to store this selection.

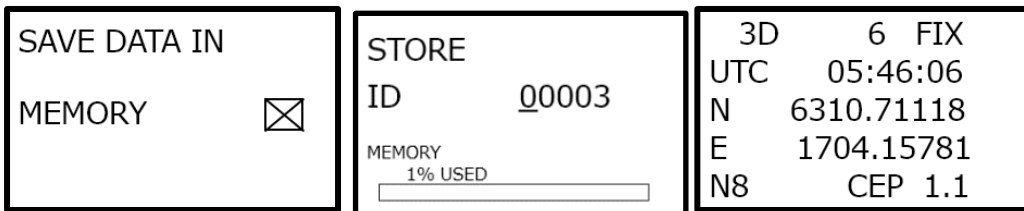

When the memory function has been enabled, all types of measurement data can be stored. Each data set is stored with a 5-position numeric attribute ID and GPS coordinate, (if the GPS function has been enabled). The ID is entered following a result, when the SEND button is pressed. The data will be stored in the data files **DATA.CSV** and **DATA.KML** in library **VL_GEO:\DATA** or **L_GEO:\DATA**. Trail and map data are stored in separate files.

CLEAR MEM.

Use to delete all data in your GEO instrument. Make sure to copy or move your data files to a folder on your computer before executing the Clear Mem. Function!

1. Press ON to activate the instrument.
2. Select **SETTINGS** from the main menu, then menu **MEMORY** and press ON.

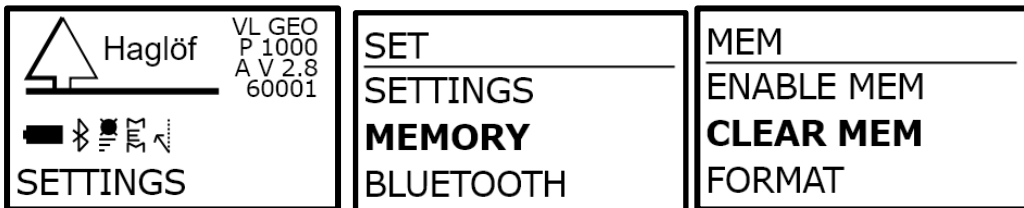

3. Select **CLEAR MEM** and press ON to confirm this selection.
4. Use the DME- or SEND button to tick the **DELETE** box, then press ON to delete your data files.

FORMAT

Use to format the SSD drive to delete all data in the GEO instrument. Make sure to copy or move your data files to a folder on your computer before executing the Format function!

Use the DME- or SEND button to tick the **DELETE?** Box. Press ON to format and delete your data files.

INFO

INFO tells how much memory the Instrument has used.

SEND FILES VIA BLE

Stored files in the GEO instrument (CSV- and KML-files) can be sent via BLE (Bluetooth Low Energy) to an external unit, e.g. to the application Haglöf Link for iOS and Android.

1. Press ON to activate the instrument.
2. Select **SETTINGS** from the main menu, then menu **MEMORY** and press ON.

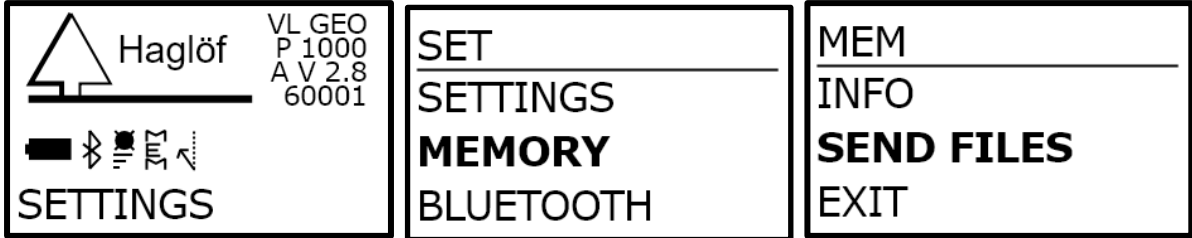

3. Select **SEND FILES** and press ON to confirm this selection.
4. Use DME- or SEND button to tick the **ALL** box, then press ON to store this selection.

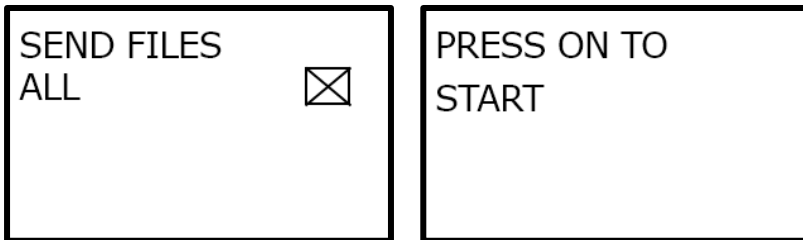

5. Start the application in the unit that is going to receive the files and let the unit connect to the GEO instrument.
6. Press ON to start transfer the files.

CONNECT THE INSTRUMENT TO THE COMPUTER

1. Press ON to activate the GEO instrument.
2. Connect the Instrument to a computer with the mini USB cable. The instrument automatically goes to USB mode. The instrument appears as a removable drive on Windows computer and as a mounted volume on Mac computers

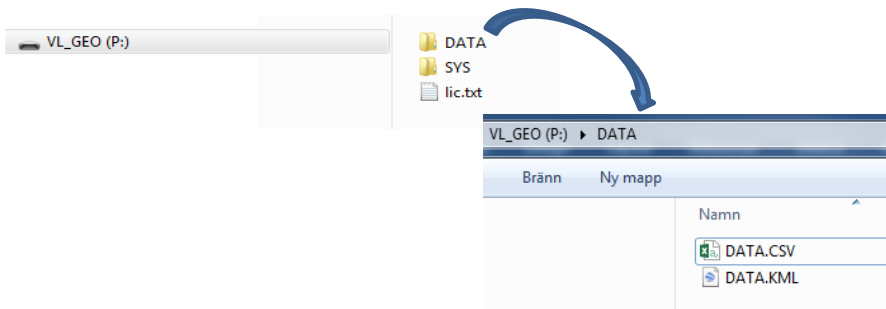
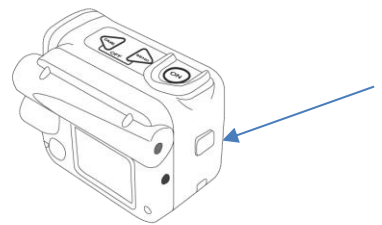

3. Browse your computer for the **VL_GEO:\DATA** folder.
4. Make sure to copy or move your data files to a folder map on your computer.
5. Your height- and 3D vector data is stored in the **DATA.CSV** file (semi colon separated) and in the **DATA.KML** file (GIS file). The CSV- and KML-files can be opened directly with your favorite spreadsheet software and GIS software such as Excel and Google Earth. Trail data is stored in **TRAILXXX.CSV** and **TRAILXXX.KML** and map data is stored in **MAPXXX.CSV** and **MAPXXX.KML** or **MAPGPSXXX.CSV** and **MAPGPSXXX.KML** where XXX is the ID.
6. It is recommended to free disc space by executing menu **MEM CLEAR** in the Instrument when the data files have been copied and stored to your computer.

DATA CSV FIELDS

All fields are semicolon separated ‘;’ and decimal sign is ‘.’ .

MARK ‘\$’ (‘\$’=Data, ‘#’=SETTINGS, ‘&’=reference point), **STATUS** (1=Valid, 0=Deleted), **TYPE** (“TRAIL”)
PROD Product ID (1000), **VER** Firmware version (12), **SNR** serial nr (12324)
ID Target Identity (00001), **UNIT** unit (‘M’=Metric, ‘F’=Feet), **TRPH** Transponder height (1.3), **REFH** Eye height (1.7), **P.OFF** Pivot Offset (0.3), **DECL** Magnetic declination (1.0), **LAT** Target Latitude decimal degree, (63.1784017), **N/S** North South (‘N’=North, ‘S’=South), **LON** Target Longitude decimal degree (17.0703634), **E/W** East West (‘E’=East, ‘S’=West), **ALTITUDE** Altitude above mean sea level (10), **HDOP** GPS horizontal dilution of precision (0.8), **DATE** MMDDYY (070817), **UTC** GPS Coordinated Universal Time (104800), **SEQ** Measuring sequence (1), **AREA** Target area (-), **VOL** Target volume(-), **SD** Slope distance (23.6), **HD** Horizontal distance (23.5), **H** Target height (-0.2), **PITCH** Pitch to target (-4.5 degree), **AZ** Azimuth to target (117.4 degree), **X(m)** Target X-coordinate (north) relative starting point (7007147.1), **Y(m)** Target Y-coordinate (east) relative starting point (604215.2), **Z(m)** Target Z-coordinate (up) relative starting point (-0.2), **UTM_ZONE** Utm zone

TYPE OF MEASURING

“3D”	3D vector
“COMPASS”	Compass
“TARGET”	Map Target
“TRAIL”	Map Trail
“1P”	1 point using 1-point laser distance
“3P”	3 point using 1-point laser distance
“ANGLE”	Angle
“DME”	2 point height using 1 point DME distance
“DMELASER”	2 point height using 1 point laser distance
“GPSPOS”	Single Coordinate

CSV FILE EXAMPLE (FORMATTED)

MARK STATUS TYPE PROD VER SNR ID UNIT TRPH REFH P.OFF DECL LAT N/S LON E/W ALTITUDE HDOP DATE UTC SEQ...
 # SET 1000 10 62324 M 1.3 1.7 0.3 1.0
 \$ 1 TRAIL 1 63.1784017 N 17.0703634 E 10 0.8 104800 00 1 23.6 23.5 -0.2 -4.5 117.4 7007147.1 604215.2 -0.2
 \$ 1 TRAIL 1 63.1784342 N 17.0706543 E 10 0.8 104800 2 15.1 15.0 0.2 -5.7 75.3 7007150.9 604229.8 0.0

CSV FILE EXAMPLE 2

MARK;STATUS;TYPE;PROD;VER;SNR;ID;UNIT;TRPH;REFH;P.OFF;DECL;LAT;N/S;LON;E/W;ALTITUDE;HDOP;DATE;UTC;SEQ;AREA;VOL;SD;HD;H;PITCH;AZ;X(m);Y(m);Z(m);UTM_ZONE;

##;SET;1000;11;-1;;M;1.3;1.7;0.3;0.0;,,,,,,,,,,,,;
 \$;1;3D;;;1;,,,,,,,,,,,,;3;;;0.9;0.9;-0.1;-3.6;267.6;-0.0;-0.9;2.3;
 \$;1;3D;;;2;,,,,,,,,,,,,;3;;;0.4;0.4;0.0;3.9;314.0;0.3;-0.3;2.1;
 \$;1;3P;;;3;,,,,,,,,,,,,;1;;;0.4;0.4;0.5;9.0;233.8;-0.2;-0.3;2.2;
 \$;1;1P;;;4;,,,,;63.1782227;N;17.0695719;E;107;1.0;070717;65257;1;;;3.4;2.8;3.8;34.2;137.9;7007125.6;604176.1;3.8; 33V

BLUETOOTH® – COMMUNICATION

The GEO instruments include built-in Bluetooth® for wireless transfer to PC, computer caliper or handheld computer. Some receiving units will ask for a pin-code to initiate connection. The default code in the instrument is 1234.

The connection distance between two units with Bluetooth should not exceed 10-50 M or 32-160 FT.

Note: When activating the memory function, the ability to send data via Bluetooth or IR is disabled.

ACTIVATE BLUETOOTH®

1. Press ON to activate the instrument.
2. Select **SETTINGS** from the main menu, step to **BLUETOOTH** and press the ON button.

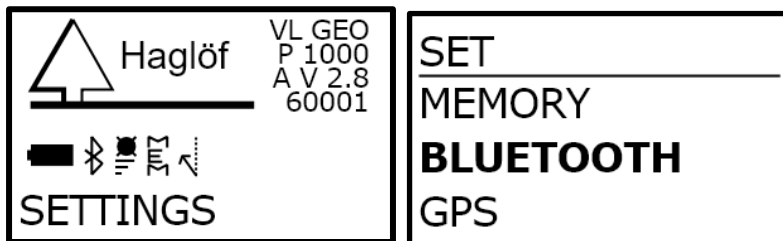

3. Use the default code 1234.
4. Use the DME- or SEND button to tick the **BLUETOOTH** box, then press ON to save this setting. External units can now connect to the Instrument (Bluetooth serial profile).

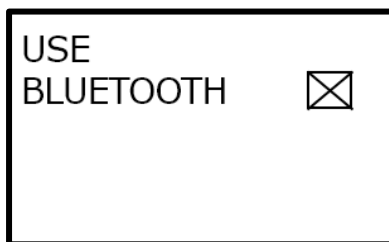

Data is sent when pressing the SEND button on the GEO instrument.

IR – COMMUNICATION

Data can be sent with IR (infrared light) to the Haglöf Sweden Digitech® Professional or DP II computer calipers. Data from the Instrument is sent serially via Bluetooth or IR as text. Data is sent when pressing the SEND button. To enable IR- or Bluetooth data transfer, the data storage function (ENABLE MEM) must first be deactivated in the MEMORY menu.

1. Activate the IR receiver (see Digitech Professional caliper user's guide)
2. Aim at the GEO instrument's IR port with the IR receiver and press SEND.
3. Repeat point 2 if needed.

The distance between the Instrument and the IR receiver should not exceed 10 cm.

DATA FORMAT

IR - HAGLOF

The IR Data packet contains a total of 40 signs.

```
1 0000<LF><CR>
2 0000<LF><CR>
3 0000<LF><CR>
4 0000<LF><CR>
5 +000<LF><CR>          (At negative angle '+'is replaced with '-')
```

<LF>=Linefeed (ASCII 10)

<CR>=Carriage Return (ASCII 13)

At height measuring, the following is sent

```
Line 1:      1:a height (dm alt. feet X 10)
Line 2:      2:a height (dm alt. feet X 10)
Line3:       3:e height (dm alt. feet X 10)
Line 4:      Horizontal distance to the object (dm alt. ft X 10)
Line 5:      Angle to object (grads X10)
```

At distance measuring the following is sent:

```
Line 1:      0000
Line 2:      0000
Line 3:      0000
Line 4:      Distance to transponder (cm alt feet X 10)
Line 5:      Angle to object (grads X10)
```

BLUETOOTH - NMEA

The NMEA format sends height, horizontal distance, angle and azimuth to the object

\$PHGF,HVV, HDvalue,units,AZvalue,units,INCvalue,units,SDvalue,units,Heigth, unit,*csum<CR><LF>

\$PHGF,	is the message identifier
HVV,	is the type of data, in this case horizontal and vertical vector
HDvalue	Calculated Horizontal Distance. One decimal place.
Units	F=feet, M=meters
AZvalue	Measured Azimuth. One decimal places.
Units	D=Degree
INCvalue	Measured Inclination value. One decimal place.
Units	D=Degree
SDvalue	Measured Slope Distance Value. One decimal place.
Units	F=feet, M=meters
H value	Calculated Height Value. One decimal place.
Units	F=feet, M=meters
*csum	
<CR>	Carriage Return
<LF>	Line Feed

Example:

Ex: \$PHGF,HVV,10.2,M,2.3,D,38.4,D,10.4,M,21.6,M,*3F

BLUETOOTH BLE

The GEO instrument allows data transfer with Bluetooth Low Energy (BLE) devices, usually supported by Android and iOS. The transfer requires an App that supports the GATT service below. Data is sent by pressing the SEND button on the GEO instrument after a measurement.

service uuid = "9e000000-f685-4ea5-b58a-85287cb04965"

characteristic uuid = "9e010000-f685-4ea5-b58a-85287cb04965"

Total 20 bytes:

Byte 0-3	horizontal distance	(m x10)	"0" .. "9999"
Byte 4-7	distance	(m x10)	"0" .. "9999"
Byte 8-11	height	(m x10)	"0" .. "9999"
Byte 12-15	vertical angle	(° x10)	"-900" .. "900"
Byte 15-19	horizontal angle	(° x10)	"0" .. "3600"

HOW TO CALIBRATE THE COMPASS

The Instrument is factory calibrated. There are no removable parts in the GEO instrument, and there is normally no need to recalibrate the compass. If the Instrument is exposed to a strong magnetic field, a recalibration is recommended, and this can be performed in **CAL.COMPASS**.

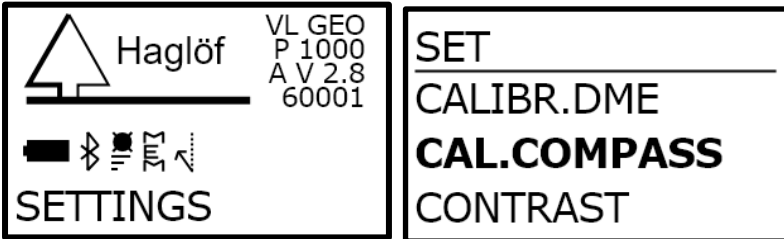

To calibrate the compass:

1. Select **SETTINGS** in the main menu and step to **CAL.COMPASS**. Press ON.
2. Use the DME- or SEND button to tick the **CALIBRATE** box. Press ON to continue.
3. Use the DME- or SEND button to tick the **SURE** box, then press ON to continue.

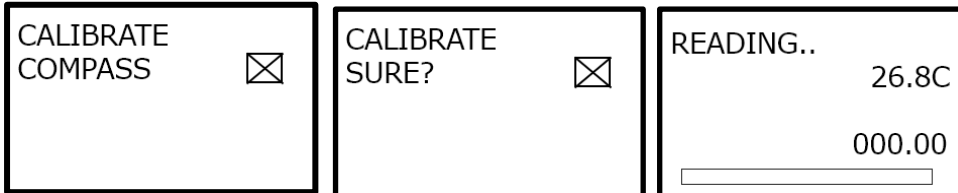

4. Aim the Instrument to north and start to rotate the Instrument around each axis, one at a time. The slower and steadier the rotation, the better chance of achieving an accurate calibration. The rotation should take approximately 30 seconds to complete. Any interruptions in this motion can cause errors in the pitch and roll, as they are perceived as an acceleration to the sensors.
5. Press ON when ready.
6. Use the DME- or SEND button to tick the **CALIBRATE** box if inaccuracy is less than 1%. Press ON to confirm and calibrate.

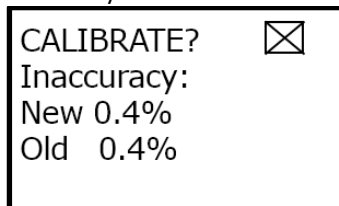
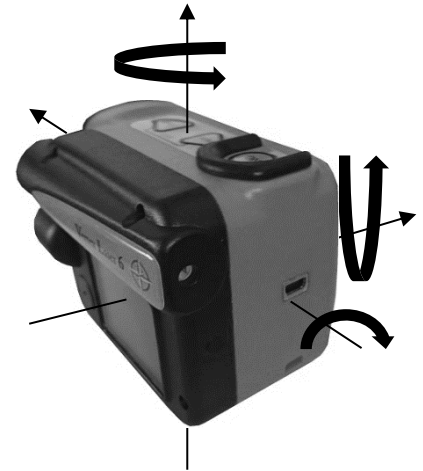

COMPASS TEST

Use the **SETTINGS / TEST / COMPASS** menu to test the compass.

1. Point the GEO instrument towards a target 10m-50m away.
2. Press ON to measure direction 1.
3. Go to the target and turn 180 degrees.
4. Point the GEO instrument against your previous start point.
5. Press ON to measure direction 2.
6. The difference **DIFF** between directions 1 and 2 should be $180^\circ + -4^\circ$



 Haglöf
VL GEO
P 1000
A V 2.8
60001

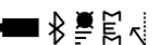

SETTINGS

SET
CONTRAST
TEST
EXIT

AIM

AT A
DIRECTION

AIM

180°
REVERSE

DIFF= 178.5°

DIF
179

FIRMWARE UPGRADE

The firmware in the Instrument can be user upgraded for new program releases or custom designed firmware with new functionality.

1. Press ON to activate the GEO instrument.
2. Connect the Instrument to a computer with the mini USB cable. The instrument automatically goes to USB mode. The Instrument appears as a removable drive on Windows computer and as a mounted volume on Mac computers. Copy the firmware file to the instrument's root library. **xxxxx_1000_V10.VL6** (product "1000", version "10"). Note: Major firmware changes or custom firmware's may require an extra license file **LIC.TXT**. This license file should also be copied to the root library.

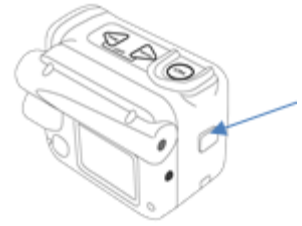

3. Turn off the instrument.
4. Press the SEND button when the instrument has been turned off and keep the SEND button pressed. Insert the USB cable to start the upgrade.
5. Remove the USB cable when upgrade is completed.

TECHNICAL SPECIFICATION

Note that this technical specification includes descriptions for ultrasound valid for the VERTEX LASER GEO model only

Physical	
Dimensions (L x W x H)	3.7x2.5x2.8" (93x63x72mm)
Weight	8.6oz(243g)
Housing and frame material	Glass filled polycarbonate
Shock/Vibration	MIL-STD-810E
Moisture	IP67, NEMA 6
Monopod/tripod mount	1/4" female thread
Operating temperature	Temperature range -20° to +45°C / -4F to 113F

Power	
Power consumption	Max 0.9W
Battery duration	Approx. 2000 measurements
Battery type	Chargeable Li-Ion 3.7V
Charging time	Max 3.5h
Charger interface	USB mini B
Charger	Wall charger 110/220AC-5VDC, USB mini B interface
Car charger	Car Cigarette Lighter Adapter 12VDC , USB mini B interface
Cable	USB mini B Male/USB Type A Male, 0.5m

User interface	
Buttons	3 multi-functional buttons
Buzzer	Yes
Display	Graphic LCD 100x60pixel
Bluetooth	class 2, Spp (serial profile), pin code 1234
Bluetooth data format	Nmea
Bluetooth BLE GATT server	Distance (dm), height (dm), pitch and yaw (° x10) in GATT database. (iOS, Android)
IR	Haglöf standard format
Sight	Heads up display, 1x magnification

Memory	
Capacity	2000 sets of data
Memory type	Non volatile
Data file	CSV, KML

USB	
Version	2.0
Device class	USB mass storage device class
Storage capacity	8Mb

Height	
Range	0-999.9 m/ft
Resolution	0.1m/ft

Vertical Angle	
Units Angle	Degrees 360°, Grads 400° and %
Angle range	-90.0° to +90.0°
Resolution angle	0.1°
Accuracy	0.1°

Horizontal Angle (Compass)	
Units Angle	Degrees 360 ⁰
Angle range	0.0 ⁰ to 359.9 ⁰
Resolution angle	0.1 ⁰
Accuracy	1.5 ⁰ RMSE

Laser	
Min range	1.5ft/46cm
Max range	2000ft/700m (depending on target)
Accuracy	0.1ft /4 cm
Resolution	0.1ft /0.1m (0.01m/0.1ft when using laser in DME mode)
Target modes	First, Last, Strongest
Wavelength	905nm
Divergence	3 mrad (1ft beam diameter @ 328ft (30cm @ 100m)
Free aperture	0.91in/23 mm
Eye safety	Class 1, 7mm (FDA, CFR21) Class 1m (IEC 60825-1:2001)

THE INSTRUMENT COORDINATE SYSTEM

The GEO instruments use these directions of X, Y, Z axes:

- a. Z=Up
- b. X=North
- c. Azimuth 0..360°
- d. Y=East
- e. Angle -90°...90°

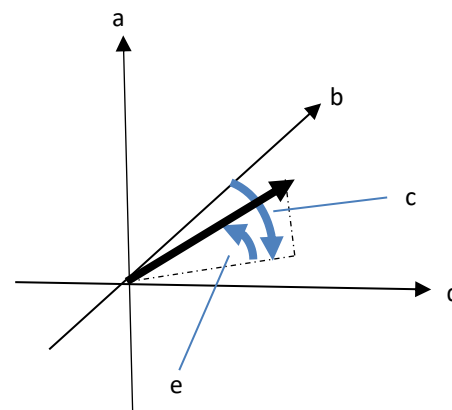

GPS Features	
Host-based multi-global navigation satellite system:	GPS(USA)/GLONASS(Russia)/Galileo(EU)/QZSS(Japan)
SBAS Satellite-based augmentation systems:	WAAS(USA), EGNOS(EU), GAGAN(India), MSAS(Japan)
Built in self-generated orbit prediction (Faster TTFF up to 3days)	
Built in jamming removing	

GPS Interfaces	
Geodetic datum	WGS84
Protocol NMEA	
NMEA messages:	
GGA	Time, position and fix type data.
GLL	Lat, long, UTC time of position fix and status.
GSA	GNSS receiver operating mode, satellite used, DOP values.
GSV	Number of satellites in view ID numbers, elevation, azimuth and SNR values.
RMC	Time, date, position, course and speed data.
VTG	Course and speed information relative to the ground.

GPS Performance Data	
Receiver type 33tracking/99 acquisition- channel GNSS receiver	
Update rate	1Hz
Sensitivity	
Tracking:	-165 dBm
Reacquisition:	-160 dBm
Cold starts:	-147 dBm
Time-To-First-Fix	(All SV @ -130 dBm)
Cold starts:	28s up to 15min (open sky)
Warm starts:	26s (open sky)
Hot starts:	<1s (open sky, <2h since last start)

GPS Accuracy	
Automatic Position	2.5m CEP (circular error probable) (50% 24 hr static, -130dBm)
Speed	0.1m/s (50%@30m/s)*
Operation temperature:	-40°C~+85 °C

Ultrasound	
Distance (max) to transponder T3	>30m/100ft
Distance (max) to T3 with 360° adapter	>20m/60ft
Resolution	0.01m/0.1ft
Accuracy	1% or better when calibrated

Transponder T3	
Size: Diameter	70mm / 2.8"
Weight	85g/5oz (battery included)
Battery	1x 1,5V AA Alkaline
Power consumption	9mW

Other	
Adapter/Spreader	Plastic, weight app. 30g/1oz
Monopod/plot staff	4-parts, 33-140cm, weight app. 270g/9.5oz, aluminium/plastic. Camera-type monopod staff with foot-bracket and 1/4-20 mount
Monopod non-magnetic	Custom built 2-parts non-magnetic monopod with ¼ 20" threading for mounting on instrument
Case	Soft instrument carrying case. Transport case in aluminium.

ERROR DETECTION

LASER

Symptom	Check points
Laser will not start/Display will not light up	Charge battery
Distance to target not reached	<p>Ensure that the laser beam is not blocked in the laser sensor or detector. Ensure that laser lenses are clean. If necessary, clean these parts (See section on Care, storage and maintenance, this document).</p> <p>Target shape and color not suitable for laser reflection. Thin and small surfaces, targets with diffuse reflection surface, targets with considerable depths, targets through glass surfaces; snow, rain, dusk, fog.</p> <p>Control setup laser mode in the Settings menu. First-Strongest-Last. If necessary, charge battery.</p>
Not possible to measure close by targets	Make sure that target is not blocked
Targets outside of certain distance cannot be measured	Make sure that target is not blocked
Unstable and uncertain measuring results	<p>Charge battery</p> <p>Ensure that target shape and conditions can reflect laser beam.</p> <p>Hold the instrument steady and press ON.</p> <p>Make sure that target is not blocked</p>
Incorrect measuring results are presented	<p>Charge battery</p> <p>Ensure that target shape and conditions can reflect laser beam.</p> <p>Make sure that target is not blocked Check laser mode settings in the Settings menu. First-last-strongest</p>

ULTRASOUND

Symptom	Check points
No distance presented in display	<p>Ensure that transponder is on/active.</p> <p>Poor battery.</p> <p>Repeated noise in surroundings (chain saws, highway traffic, crickets...)</p> <p>Use of wrong type of transponder</p>
Measured distance values unstable	<p>Repeated noise in surroundings (chain saws, highway traffic, crickets...)</p> <p>Calibrate ultrasound (VL GEO).</p>
Red aim dot will not go out	<p>Ensure transponder to be on/active.</p> <p>Poor battery.</p> <p>Repeated noise in surroundings (chain saws, highway traffic, crickets...)</p> <p>Use of wrong type of transponder Angle to object to large – increase distance to object.</p>
VL GEO/ L GEO unit will not start	Poor battery, charge needed.
Transponder unit will not start	Poor battery
No presentation of measuring results	<p>Ensure transponder to be on/active.</p> <p>Poor battery. Repeated noise in surroundings (chain saws, highway traffic, crickets...) Use of wrong type of transponder Angle to object to large – increase distance to object.</p> <p>Measuring instrument is not held steady. Instrument has not registered any horizontal distance.</p>
Unrealistic or incorrect measuring results	<p>Repeated noise in surroundings (chain saws, highway traffic, crickets...)</p> <p>Measuring instrument is not held steady</p>

COMPASS

Symptom	Check points
Azimuth result is wrong	<p>Ensure that no metallic- or magnetic objects are too close to the GEO instrument. Metallic framed eye wears, mobile phone, pace maker, power line etc. can affect the function. Check the declination in menu SETTINGS.</p> <p>Keep the VL GEO / L GEO steady during measuring.</p> <p>Recalibrate the compass if necessary.</p>

COMPLIANCE STATEMENTS/DÉCLARATION DE CONFORMITÉ

CE	<p>Product Origin: Sweden (EC)</p> <p>Declaration of Conformity: Haglöf Sweden AB hereby declare under our sole responsibility that the Vertex Laser Geo/Laser Geo instrument complies with the requirements of the following applicable European Directives: Electromagnetic Compatibility (EMC) Directive 2014/30/EU, Low-Voltage (Safety) Directive 2014/35/EU, RoHS Directive 2011/65/EU,</p> <p>Conformity is assessed in accordance to the following standards: Emission: EN 61000-6-3:2007, A1:2011 Immunity: EN 61000-6-2:2005, EN 61000-4-2, -3</p> <p>Approved Okt 16 2017, Joakim Nygren R&D Manager, Haglöf Sweden AB Report nr 17070 by KEMET, Thörnblads väg 6, 386 90 Färjestaden, Sweden</p>
FCC	<p>This device, The VERTEX LASER GEO/LASER GEO, containing FCC ID QQQT121, complies with part 15 of the FCC Rules. Operation is subject to the following two conditions:</p> <p>(1) This device may not cause harmful interference, and (2) this device must accept any interference received, including interference that may cause undesired operation.</p>
FCC PART 15.21 STATEMENT	<p>Changes or modifications not expressly approved by the party responsible for compliance could void the user's authority to operate the equipment.</p> <p>User modifications / changes</p> <p>This equipment has been tested and found to comply with the limits for a Class A digital device, pursuant to part 15 of the FCC Rules. These limits are designed to provide reasonable protection against harmful interference when the equipment is operated in a commercial environment. This equipment generates, uses, and can radiate radio frequency energy and, if not installed and used in accordance with the instruction manual, may cause harmful interference to radio communications. Operation of this equipment in a residential area is likely to cause harmful interference in which case the user will be required to correct the interference at his own expense.</p>
IC CANADA	<p>This device, the VERTEX LASER GEO/LASER GEO, containing IC 5123A-BGTBT121 complies with Industry Canada's license-exempt RSSs. Operation is subject to the following two conditions:</p> <p>(1) This device may not cause interference; and (2) This device must accept any interference, including interference that may cause undesired operation of the device.</p> <p>Ce produit, VL/LASER GEO, IC ID 5123A-BGTBT121, est conforme au Chapitre 15 du Règlement FCC et le RSS du Règlement IC. L'utilisation est soumise aux deux conditions suivantes:</p> <p>(1) le périphérique ne peut pas causer d'interférences nuisibles et (2) l'appareil doit accepter toute interférence en réception, y compris les interférences causant un dysfonctionnement de l'appareil.</p>
SOUTH KOREA CERTIFICATE	<p>Certificate of broadcasting and communication equipment's no. MSIP-CRM-BGT-BT121.</p>
JAPAN	<p>This equipment contains specified radio equipment that has been certified to the technical regulation conformity certification under the radio law.</p> <p> R209-J00171 当該機器には電波法に基づく、技術基準適合証明等を受けた特定無線設備を装着している。</p>

WARRANTY AND SERVICE INFORMATION

The Vertex Laser GEO/Laser GEO is covered by a one-year limited warranty. Haglöf Sweden AB warrants that this product shall be free from defects in materials and workmanship, under normal intended use, for a period of 12 months after date of shipment. The warranty excludes the batteries, the accessories and any written materials. The warranty does not apply if the product has been improperly installed, improperly calibrated or operated in a manner not in accordance with the user's guide. Warranty is also automatically expired if the product has been opposed to external force and warranty is not applicable for cosmetic defects. The one-year limited warranty time covers obvious fabrication defects. Defects in the electronic components that are impossible for the manufacturer to detect prior to assembling and shipping of the product may occur. Haglöf Sweden AB can in no case be responsible for problems of this nature and has no liability for any loss of business, profits, savings, consequential damages or other damages resulting from use of the products described. Signs of misuse, cosmetic damage, accidents or equal automatically withdraw the warranty. The warranty is valid in the country where your Haglöf product has been purchased. A product covered by warranty will be subject to exchange, service, and repair or according to special agreement between seller and buyer, within the frames of the limited warranty. Haglöf Sweden reserves the right to determine which option will be most suitable for each separate case after having examined and evaluated the product. Contact manufacturer for complete warranty and service information.

SAFETY AND OPERATION PRECAUTIONS

To avoid injury or material loss, please read this safety and operation precautions thoroughly:

- Never look directly at the laser beam or directly at the sun when using the instrument.
- Do not use the instrument together with other optical instruments, such as binoculars and lenses. Using an optical instrument together with the instrument increases the danger of eye damage.
- Do not depress the ON button while aiming with the eye or looking into the optics from the objective side.
- Do not disassemble the instrument. Any signs of disassembling automatically withdraw any warranties and the manufacturer does not guarantee the product.
- Never place the instrument in an unstable place.
- Never look through the instrument while walking.
- If you should develop any symptoms of eye irritation or skin inflammation around the eye due to use of the instrument, consult a doctor immediately.
- If the instrument should fail to operate correctly, discontinue use and consult the manual. If you are unable to fix the problem, contact your local dealer for instructions or where to send the instrument for repair.
- The instrument has built-in Bluetooth® for data transfer to external devices. There may be local restrictions on the use of both Bluetooth® and laser technology. It is the operator's responsibility to control that the technology in the instrument is permitted to use in the area where the instrument is operated.

CARE, STORAGE AND MAINTENANCE

- Store the instrument in its soft case when carrying. Do not swing the instrument by its strap.
- The instrument is water and dust resistant, but should not be used in water and it is not waterproof.
- Use a soft, clean and dry cloth to clean the instrument if exposed to rain, water, sand and mud. Do not use alcohol, benzene, thinner or other organic agents to clean the instrument's main body! Always clean as soon as possible after the exposure, and always store the instrument in a dry, cool place and away from direct sunlight.
- Use a soft oil-free brush to remove dust from the lens surface. To remove stains or smudges (fingerprints etc.), wipe lenses gently with a soft clean cotton cloth or oil-free lens tissue. To clean a lens, moisten it with lens cleaning solution and wipe it clean with a lens cloth or lens tissue. Stubborn smudges can be removed with a small amount of pure alcohol using extra care to avoid scratching of the lens surface. The tissue should only be used one time.
- Do not expose the instrument to excessive heat or ultraviolet rays, since this may damage the unit.
- When exposed to sudden changes in temperature or high humidity, water condensation may appear on lens surfaces. Do not use the instrument until this condensation has evaporated. Dry the instrument at room temperature and store in a cool, dry place.
- Keep the instrument and any parts of and for the instrument out of reach of small children. Consult a doctor immediately if a small child has swallowed any parts of the instrument or its packing.

NOTES ON BATTERIES

- Rinse skin or eyes well with water if exposed to any battery fluid. If swallowed, contact a doctor
- Do not short-circuit battery chamber terminals, and do not carry any batteries with keys or coins in a pocket.
- Keep away from fire and water and do not disassemble batteries.
- Avoid strong vibrations, shock, fluid or extremes in temperatures for all batteries. If handled incorrectly, batteries may rupture and leak, corroding equipment and staining clothing

SOFTWARE

© Copyrights of Haglöf Sweden AB Software belong to Haglöf Sweden AB. Unauthorized duplication is prohibited. Haglöf Sweden AB is registered trademark and VERTEX is a recognized trademark of Haglöf Sweden AB. Production is made in Sweden.

Haglöf Sweden and its suppliers cannot warrant the performance or results when using the firmware, software or hardware, nor the documentation. No warranties or conditions are made; neither expressed nor implied, of merchantability, suitability or special fitness for any particular purpose. If software problems appear, please contact your programmer for support. Haglöf Sweden takes no responsibility for loss of income, time, or problems and delays due to problems in soft- or hardware of products. Copyrights of all software & firmware made by Haglöf Sweden belong to Haglöf Sweden. Any lists and/or information of software for any Haglöf Sweden AB products should be considered as brief descriptions and not as a complete guide to what may and may not be available. Contact manufacturer for more information on terms and conditions.

- **Always contact your Haglöf Sweden representative/dealer where the instrument was purchased for assistance with all questions concerning service and warranty issues.**
- For a valid warranty, a copy of invoice or dated receipt of your purchase must be presented. The serial number of the returned product must be clearly stated upon return.
- The return freight to us is on buyer's expense. After warranty repair or exchange, the return freight to you is on our expense. If warranty has expired or is null and void, all freights are on buyer's expense.
- If no original invoice can be presented upon shipment, or if two years or more have passed from date of purchase, customs fees will be added by the applicable customs authorities and possibly in receiving country as well. These fees are on buyers account.
- Please do not hesitate to contact us or Haglöf Sweden AB representative for questions or comments!
- Any signs of misuse or negligence automatically withdraw our warranty commitments



**HAGLÖF SWEDEN AB
KLOCKARGATAN 8
SE-882 30 LÅNGSELE, SWEDEN
PH: +46 620 255 80
E-MAIL: INFO@HAGLOFSWEDEN.COM**

**HAGLOF INC.,
P O BOX 2548, 100 SOLLEFTEA DRIVE
MS 39110 MADISON, USA
PH: +1 601 856 5119, FAX: +1 601 856 9075
E-MAIL: SALES@HAGLOFINC.COM**

WWW.HAGLOFSWEDEN.COM

© Copyrights of Haglöf Sweden AB Software belong to Haglöf Sweden® AB. Unauthorized duplication is prohibited. Haglöf Sweden AB and VERTEX LASER are recognized trademarks of Haglöf Sweden AB. Production is made in Sweden EC.