

# 2725 SERIES

## JET FILL TENSIOMETERS

**THE MOST ADVANCED, MOST SENSITIVE INSTRUMENTS AVAILABLE FOR THE FIELD MEASUREMENT OF SOIL MOISTURE**

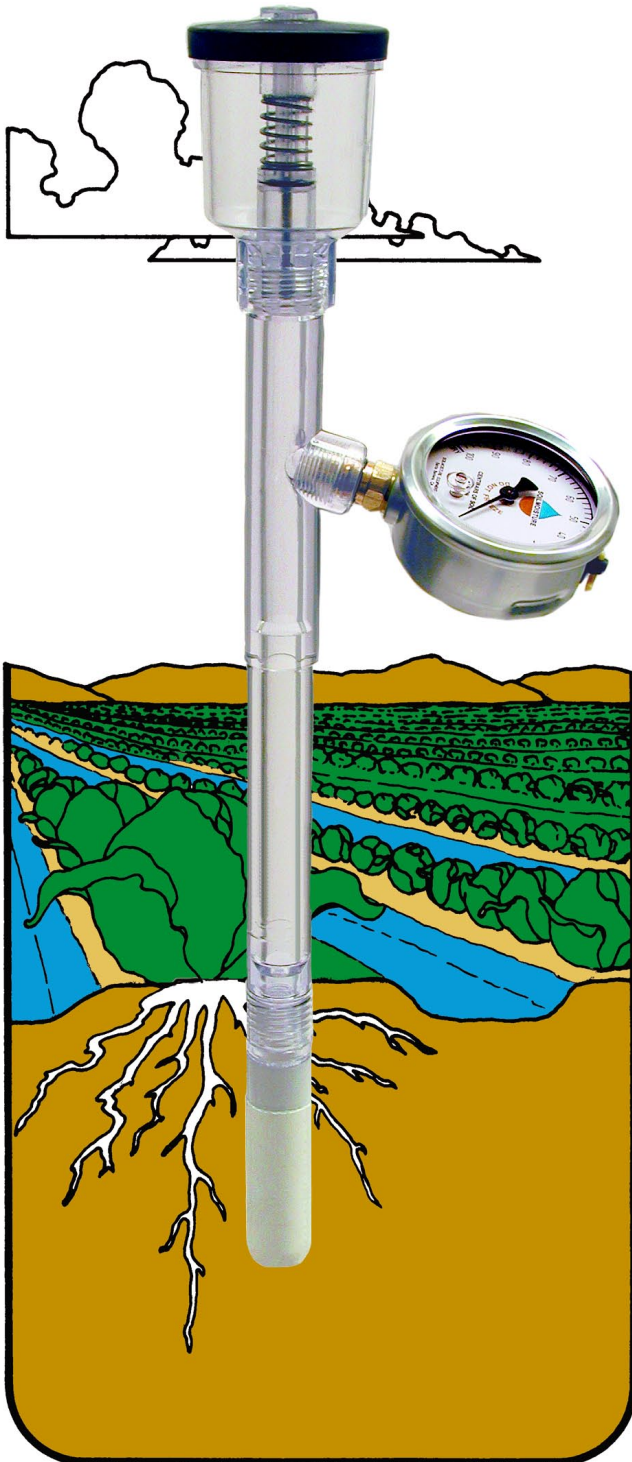

### USE THEM IN:

#### AGRICULTURE

- To tell you when to start irrigating.
- To tell you when to stop irrigating.
- To save expensive water, fertilizer, power, and labor costs.
- To improve crop yields.
- To make profits for you!

#### AGRONOMY RESEARCH

- To maintain accurate control of soil moisture during plant growth experiments in the development of superior varieties.
- To correlate physiological plant changes with surrounding soil moisture values.
- To develop effective irrigation practices for crop production.

#### HYDROLOGY

- To measure soil moisture potential to determine subsurface moisture flow.
- To verify proper moisture conditions for vadose zone soil water sampling -vital in pollution control.
- To provide essential data to relate computer modeling to actual field conditions.

**ENGINEERED AND PRODUCED BY THE FOREMOST MANUFACTURER OF SOIL MOISTURE MEASURING EQUIPMENT FOR OVER 50 YEARS.**





**SOILMOISTURE FACILITIES**

## SUPERIORITY OF SOILMOISTURE TENSIOMETERS

The Jet-Fill line of tensiometers came from a distinguished heredity line. You see the original tensiometers were developed by the founder of Soilmoisture some 60 years ago. Since that time there have been numerous coming and goings by manufacturers that thought that cheap and quick was the best way to serve the customer. At Soilmoisture we feel that quality and long term service mean more to the customer than a quick buck. All our Tensiometers are built to last providing years of quality service the long term view.

## TODAY

Today Soilmoisture offers a strong line of tensiometers with years of experience in the manufacture and design of the WORLDS BEST TENSIMETERS. From our Jet-Fill Tensiometer line described in this brochure to our line of SOILMOISTURE PROBES Model 2900 series to speciality tensiometers like our 2100 series we have one of the most complete tensiometer



2900 MODEL

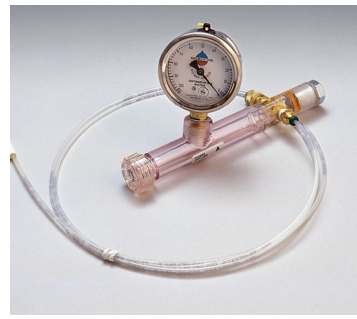

2100 MODEL

lines on the market today. We can even manufacture speciality products to meet your unusual or specific needs. If your doing work in soils research, crop production optimization, or just interested in water conservation and management we probably have the tensiometer that will fit your needs and wallet. For a full listing and description of all the possible tensiometers available please visit our web site for detailed information. If you can't find it there just give us a call or send an e-mail describing your needs and circumstances and we most likely have a solution for your.

FOR A FULL DESCRIPTION OF OUR FULL LINE OF TENSIMETERS VISIT OUR WEBSITE

<http://www.soilmoisture.com>

Visit our product pages under Tensiometer product lines, use the search word "tensiometers", or put in the actual tensiometer product number to find the tensiometer to fit your needs.

Or e-mail us at

[sales@soilmoisture.com](mailto:sales@soilmoisture.com)

Or write us at

SOILMOISTURE EQUIPMENT CORP.  
801 S. KELLOGG AVE.  
GOLETA, CALIFORNIA, 93117

## THE MODEL 2725 JET FILL IS THE BEST TENSIMETER IN THE WORLD

The flexible reservoir cover allows for convenient filling and sealing of stored water.

Time proven "O" ring seals throughout assure leak proof vacuum joints while allowing easy removal or replacement of critical components.

Angle molded port in the sidewall provides a strong connection, keeping the dial gauge continuously filled with water and easy to view. The Vacuum Dial Gauge is readily replaceable in the field and can be oriented in any position for reading convenience. Port also accepts Electrical Switching Gauge and Pressure Transducers.

Convenient molded shoulder indicates soil surface position for easy, accurate depth placement.

Heavy walled tube constructed of rigid, clear plastic assures accurate readings at high soil suction values, and is completely immune to damage by sun, water, or soil conditions. Unique superporous ceramic tip has 10 times the water conductivity of comparable units, providing the ultimate in sensitivity and long life. Convenient thread adapter design allows the ceramic tip to be readily removed or replaced, as well as permitting the addition of extension tubes to vary the placement depth of the tensiometer.

### JET FILL TENSIMETERS

The most direct and precise method of measuring soil moisture conditions in the field.

Does not require calibration.

Does not require transporting bulky measuring equipment into the field.

Does not require attaching electrical leads to make a measurement—simply look at the dial gauge.

Does not require any power source.

Can be read instantly—simply look at the dial gauge.

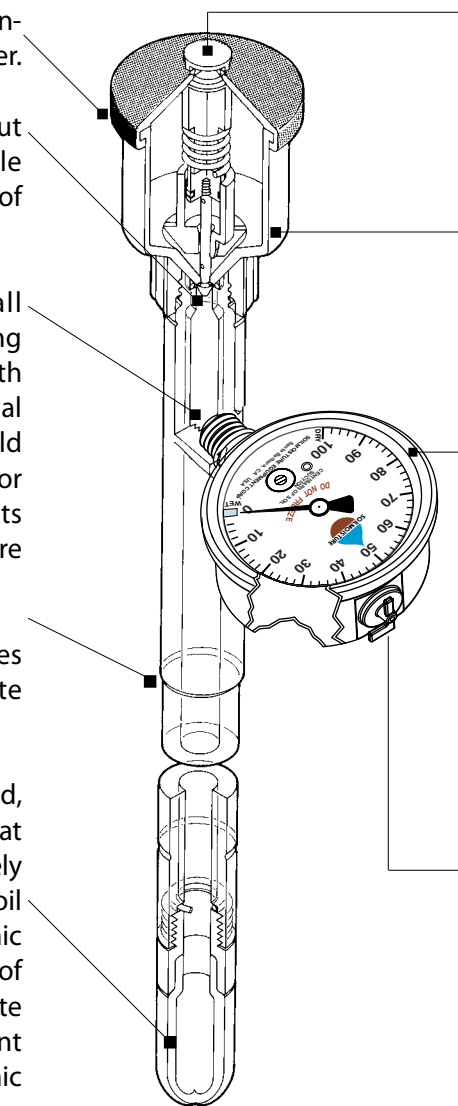

At a push of the button, the Jet Fill action instantly injects water into the body of the tensiometer and removes accumulated air with no disturbance to the soil. Recovery is in minutes - not hours!

Large volume, detachable reservoir holds sufficient water for months of servicing. All materials are completely weatherproof for years of use.

Optional recalibrator-style gauge allows for adjustment of zero point setting for careful research work. Also permits compensation for water table reference point.

The large 2 inch diameter easy-to-read dial face has a fixed pointer and is graduated from 0 to 100 centibars (Kpa) of soil suction.

The new gage sports a strong stainless steel case and unique vent valve shown here that allows one to adjust the interior gage pressure to match surrounding air. Simply turn the small valve stem and open the port to equilibrate gage internal pressure and outside pressures.

Available in nine stock lengths from 6" (15 cm) to 60" (150 cm) to meet varying installation requirements.

Extra long lengths, extension tubes and special modification supplied on short notice.

Simple "field replaceable" parts assure years of service.

The single most inexpensive instrument to give precise, direct, continuous measurement of soil moisture conditions.

Available throughout the world.



## HOW IT WORKS

Beneath the soil surface, soil particles, water, air, and plant roots share the same space. In this environment water does not move freely as it does above the surface, but is held in the grasp of the soil which determines how it will move and how plant roots can withdraw it.

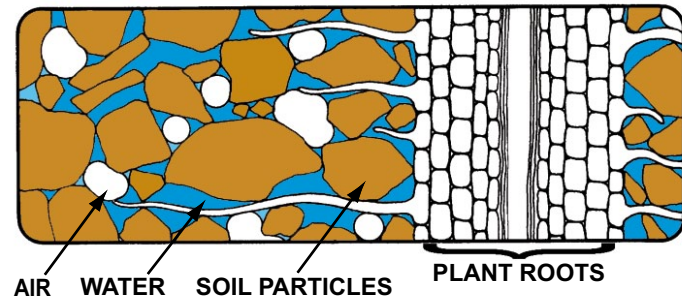

The illustration above shows how the soil particles, water, air, and roots intermingle. The water is naturally attracted to the soil particles and it sticks on the surface of each particle and in the various sized "capillary" spaces or "pores" between the soil particles. When the soil is very wet, most all the large pores are filled with water, and the water can move quite freely and can be easily removed by the plant root. As the soil dries out, the water remaining is held more tightly in the smaller sized capillary spaces.

The picture below illustrates the increasing force required to remove the water from the small sized pores compared to the large pores, as the soil dries out. Because of this, plants

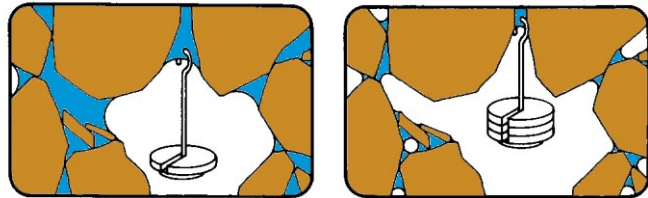

find it increasingly difficult to get adequate water as the soil dries. When remaining water is held only in extremely small pore spaces, the plants cannot exert enough force to withdraw it, and the plants wilt and die. Even though there may be a considerable volume of water in the soil, the plants can't pull it out.

Tensiometers are the only instruments that can make a direct measurement of "Soil Suction" - the force that plants have to overcome to get needed water, and the force that determines which way moisture will move in the soil. A tensiometer consists of a tube with a porous ceramic tip on the bottom, a vacuum gauge near the top, and a sealing cap. When it is filled with water and inserted into the soil, water can move into and out of the tensiometer through the connecting pores in the tip, as shown in the illustration. As the soil dries and water moves out of the tensiometer, it

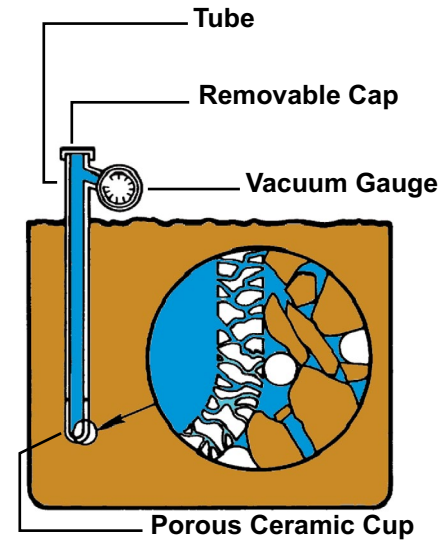

creates a vacuum inside the tensiometer which is indicated on the gauge. When the vacuum created just equals the "soil suction", water stops flowing out of the tensiometer. The dial gauge reading is then a direct measure of the force required to remove water from the soil. If the soil dries further, additional water moves out until a higher vacuum level is reached. When moisture is added to the soil, the reverse process takes place. Moisture from the soil moves back into the tensiometer through the porous tip until the vacuum level is reduced to equal the lower soil suction value, then water movement stops. If enough water is added to the soil so that it is completely saturated, the gauge reading on the tensiometer will drop to zero. Because water can move back and forth through the pores in the porous ceramic tip, the gauge reading is always in "balance" with the soil suction. The Optimum Plant Growth Range is within the operating range of tensiometers. Plants will live until the soil is so dry that the soil suction value reaches 15 bars - referred to as the "wilting point". It is within the 0-.85 bar soil suction operating range of tensiometers, however, where most all movement of moisture takes place and where the important moisture is stored for plant growth.

A "bar" is the unit of pressure that has been adopted for the expression of soil suction. The bar is an international unit of pressure, either positive or negative, in the metric system. A bar is equivalent to 14.5 lb./in<sup>2</sup> or .897 atmospheres. It is also equivalent to the pressure exerted by a height of 750 millimeters of mercury or the height of 1,020 cm of water or the height of 33.5 ft. of water. Scientifically it is defined as 106 dynes/cm<sup>2</sup>.

Tensiometer measurements are always less than 1 bar and for convenience the tensiometer scale has been divided into 100 divisions so that each division is 1/100 of a bar or "1 centibar". This is usually abbreviated as 1 cb. 1 centibar is also equal to 1 Kpa (kilopascal). The full dial gauge reading on our Jet Fill tensiometer is 100 centibars of negative pressure or vacuum.

The graph below developed through the use of our pressure membrane extractors shows the percent of moisture in the soil compared to the force of soil suction with which it is held, for three different types of soils.

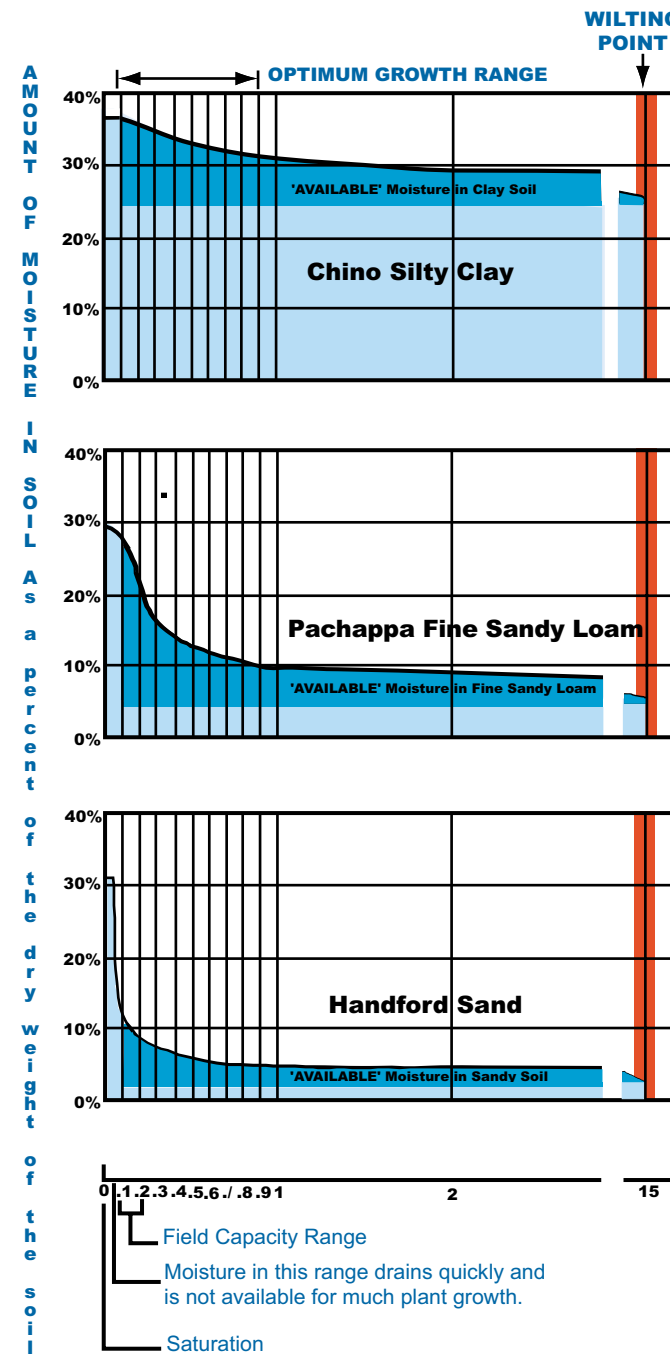

The "available" moisture for plant growth lies between the "field capacity" and the "wilting point." In general when 50 percent of the available moisture is used up, irrigation should be started. With the exception of heavy clay soils, tensiometers measure the soil suction value at which 50 percent of the available moisture is used up. In virtually all types of soils and for virtually all commercial crops, if the soil moisture is kept within the operating range of tensiometers, there will be optimum growth conditions and crop yields.

## JET FILLS ARE EASY TO INSTALL

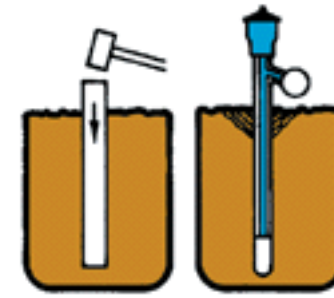

Jet Fill tensiometers are readily installed in the soil by using conventional soil sampling tools. The body tube and porous sensing tip of the tensiometer are 7/8" (2.2 cm) in diameter. Installation must be made so that the porous ceramic sensing tips in tight

contact with the soil. The Model 240 Insertion Tools can be used in rock free soils. Standard 1/2" (U.S.) steel pipe can also be used to drive a hole into the soil to accept the tensiometer. In rocky soils a soil auger can be used to core a larger hole and then the soil is sifted and packed around the porous ceramic tip to make good contact before the hole is back filled. The surface soil is tightly tamped around the body tube to seal surface water from entering.

SELECT THE PROPER LENGTH SO THAT THE POROUS CERAMIC SENSING TIP WILL BE IN THE ACTIVE ROOT ZONE.

### FOR SHALLOW ROOTED PLANTS

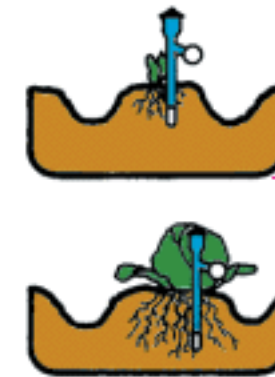

For plants with shallow root systems of less than 18" in depths, such as certain row crops, a single tensiometer with porous ceramic tip located 3/4 of the way down the root zone can give adequate information. The tensiometer tip can be located near the surface when the plant is young and then lowered as the root system develops.

### FOR DEEP ROOTED PLANTS

For deep rooted plants and trees with large root systems, two tensiometers are installed at the same location. The shallow unit has the sensing tip about 1/4 of the way down the root zone. The deep unit is 3/4 of the way down into the root zone. The shallow unit indicates when to start irrigation. The deep unit evaluates water penetration and moisture conditions at the bottom of the root zone.

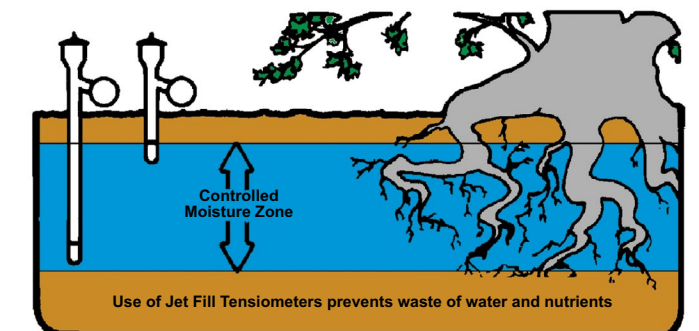

Use of Jet Fill Tensiometers prevents waste of water and nutrients



## IN AGRICULTURE

### JET FILLS ARE USED TO PROGRAM IRRIGATION WITH ALL TYPES OF IRRIGATION SYSTEMS WITH ALL TYPES OF CROPS IN ALL TYPES OF SOILS.

“Tensiometer station” is the name given to a tensiometer installation consisting of one or more tensiometers at one place. To monitor moisture conditions in the field, tensiometer stations are located in critical places, required by the irrigation system.

#### DRIP SYSTEMS

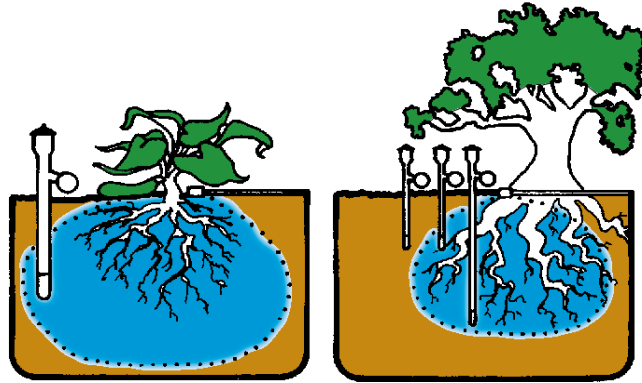

The great variety of drip emitters and bi-wall type tubing lend themselves to a wide range of application, from vast fields of sugarcane and cotton to orchards, landscaped areas, and the growing of nursery stock. This “point source” application of irrigation water, where most of the flow is underground, makes it particularly difficult to judge soil moisture conditions by surface observations. Jet Fill stations can reveal the irrigation wetting patterns in the hidden root zone.

The station is located within the wetting pattern of a typical emitter. One tensiometer placed near the emitter and down near the maximum rooting depth of the plant will provide information on penetration and when to stop the irrigation cycle. A second tensiometer placed near the lateral extent of the wetting pattern, usually 12” to 18” from the emitter and in the upper root zone will indicate when to start the irrigation cycle. The frequency of the irrigation cycle and length of irrigation can then be adjusted to keep a uniform wetting pattern with good moisture conditions throughout the pattern.

In new installations, several tensiometers placed at various depths and distances from the emitter will give definite information on the size and shape of the wetting zone.

#### PIVOTS

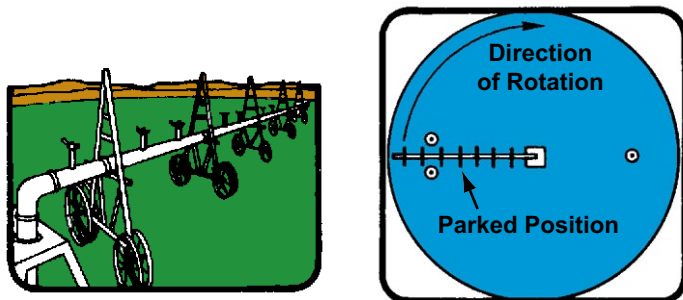

For pivots, three tensiometer stations should be used for each pivot. One station is located in front of the parked position of the pivot and between the second and third towers from the outside. A second station is located in the same position but 180 degrees away. The third station is located behind the parked position and also between second and third towers. This arrangement provides moisture information typical of the field and is ideal for determining when to start the next irrigation cycle.

#### BIG GUN/TOW-LINES

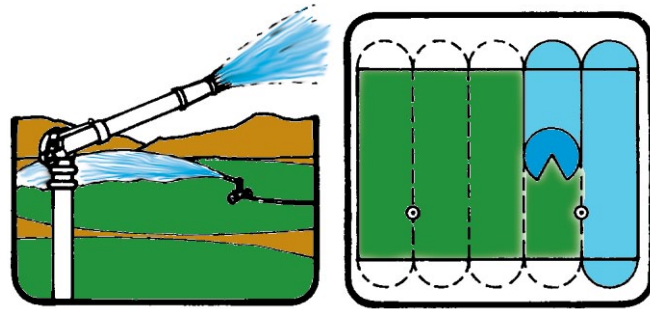

For tow lines, a station is located between the first and second sets on a field and between the next-to-last and last sets.

#### WHEEL AND HAND MOVE LATERALS

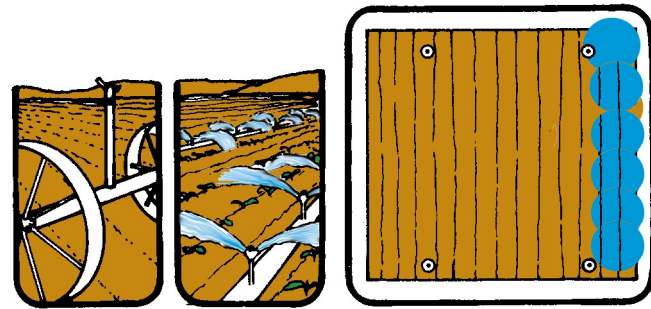

A station is located between the first and second sets on the field and between the next-to-last and last sets.

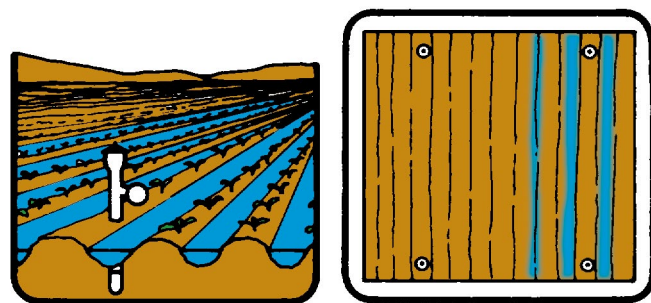

#### FURROW AND FLOOD

One station is located near the upper end and one near the lower end of the run for each field or portion of the field irrigated at the same time. Head of water and timing are adjusted in successive irrigations to get as uniform a distribution as possible, using the tensiometer readings as a guide.

#### SOLID SET SYSTEMS

Solid set irrigation systems can provide great uniformity in the application of irrigation water. A single tensiometer station located where spray is received from a full group of

adjacent sprinklers, away from the periphery of the field, can be used to schedule irrigation for each separately irrigated section.

#### SUBSURFACE IRRIGATION SYSTEMS

In some areas, a high water table during much of the year often combined with a need for irrigation during some of the summer months, makes tile drains a desirable investment. During wet periods, the system provides drainage to remove excess water. In the irrigation mode, water is fed back into the drains and up into the root zone by capillary action through the soil.

Jet Fill stations located in typical areas of the field provide the critical information to rigidly control the water table height. If the water table is too high, plant growth will be retarded or stopped completely.

## OTHER CONSIDERATIONS IN LOCATING TENSIO METER STATIONS

#### IN RELATIONSHIP TO PLANTS



For row crops, the tensiometer station is located directly in the row. A place is chosen where plant population is typical of the field.



For orchards, the tensiometer station is located just inside the drip line of the tree, preferably on the side receiving the most sun, since water will be depleted faster there.

#### IN RELATIONSHIP TO TOPOGRAPHY

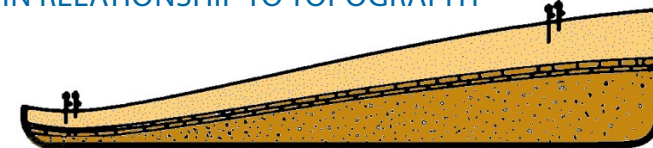

On hilly fields, tensiometer stations are located in the high and low areas, where drainage conditions may be different. Irrigation practices can be modified to keep moisture levels as uniform as possible.

#### IN RELATIONSHIP TO SOIL TYPE

Rates of penetration and storage capacity vary greatly between various soil types. Therefore, tensiometer stations should be located where the soil is most representative of the field to be irrigated. Additional stations should be located where soil type is radically different in order to provide full information for irrigation timing in those areas.

#### GOOD AND POOR GROWTH AREAS

Tensiometer stations located in the good and poor growth areas of a field will quickly reveal whether moisture conditions are the major contributing factor. If so, they will indicate the changing moisture conditions as corrections in irrigation procedures are made.

#### UNEVEN IRRIGATION DISTRIBUTION

Variations in sprinkler head output, water pressure, wind action, and other factors can result in uneven distribution of irrigation water. Tensiometer stations located in suspected areas can provide positive data on which to base corrective action.

**JET FILL TENSIO METERS ALONE WILL PROVIDE THE INFORMATION YOU NEED FOR A COMPREHENSIVE IRRIGATION SCHEDULING PROGRAM.**



**WITHOUT THE NEED FOR INVOLVED WATER DEPLETION CALCULATIONS, THE TENSIO METER READING GIVES INSTANTLY THE CURRENT STATUS OF THE VITAL SOIL MOISTURE, AUTOMATICALLY SHOWING THE RESULTANT EFFECT OF CHANGING WEATHER CONDITIONS, CONSUMPTIVE USE, IRRIGATION AND RAINFALL.**

**RECORDING THE TENSIO METER READINGS GIVE YOU A VISUAL PICTURE OF THE RATE AT WHICH PLANTS ARE WITHDRAWING MOISTURE FROM THE SOIL—TO PLAN WHEN THE NEXT IRRIGATION CYCLE SHOULD START.**



**WITH SHALLOW AND DEEP JET FILL TENSIO METERS SPANNING THE ACTIVE ROOT ZONE, AND BY KNOWING THE AMOUNT OF IRRIGATION WATER APPLIED, OR THE LENGTH OF THE CYCLE, YOU CAN QUICKLY DETERMINE DURING SUCCESSIVE CYCLES THE AMOUNT OF IRRIGATION REQUIRED TO REPLENISH THE ACTIVE ROOT ZONE.**

**FOR ALL OTHER SCHEDULING SYSTEMS, JET FILL TENSIO METERS CAN PROVIDE THE LINK BETWEEN THE PROJECTION THEORY AND ACTUAL FIELD CONDITIONS.**





## WHAT DO THE JET FILL READINGS TELL YOU ABOUT IRRIGATION SCHEDULING?

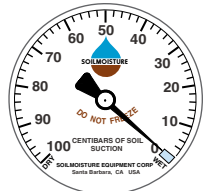

**ZERO:** A gauge reading of zero means the surrounding soil is completely saturated with water, regardless of the type of soil. Zero readings can be expected after a heavy rain or deep irrigation. If the zero reading persists after a long period of time, there will be oxygen starvation to plant roots and development of diseases. A persistent zero reading after irrigation indicates poor drainage conditions which should be investigated and corrected.

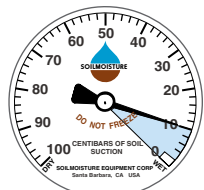

**0-10 CENTIBARS:** Gauge readings in the range of 0-10 cb indicated a surplus of water for plant growth. Water held by the soil in this range drains off within a few days. Persistent readings in this range indicate poor drainage conditions which should be corrected to obtain healthy plant growth.

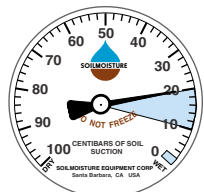

**10-20 CENTIBARS:** Gauge readings in the range of 10-20 cb indicate that there is ample moisture and also air in the soil for healthy plant growth in all types of soils. This range is often referred to as the “field capacity” range for soils, which means that the soil has reached its “capacity” and cannot hold anymore water for future plant growth. When soils are at “field capacity”, any additional water that is added drains out of the root zone within a day or two—before it can be used by the growing plant. If irrigation has been in process, it should be stopped when gauge drops to this level, since any further additional water will be quickly drained from the root zone and wasted, carrying with it valuable fertilizer.

**HEAVY CLAY SOILS:** No irrigation required at this time.  
**MEDIUM TEXTURED SOILS:** No irrigation required at this time.  
**SANDY SOILS:** No irrigation is usually required. These soils, however, have a very limited water storage capacity and therefore soil suction values increase very rapidly as moisture is removed by the plant after soil suction values reach 15-20 cb (see chart on Page 5). If water-sensitive plants, such as potatoes, are planted in coarse, sandy soils, irrigation may need to be started between 15-20 cb to allow time to apply the irrigation water before damaging stress conditions develop.

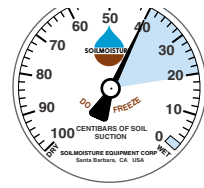

**20-40 CENTIBARS:** Available moisture and aeration good for plant growth.  
**HEAVY CLAY SOILS:** No irrigation required.  
**MEDIUM TEXTURED SOILS:** No irrigation required.  
**SANDY SOILS:** Irrigation started for coarser sandy soils in the 20-30 cb range. For finer sandy soils in the 30-40 cb range.

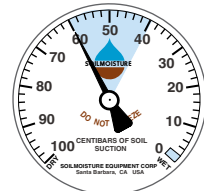

**40-60 CENTIBARS:** Available moisture and aeration are good for plant growth in finer textured soils.  
**HEAVY CLAY SOILS:** No irrigation required.  
**MEDIUM TEXTURED SOILS:** Irrigation started in this range. The finer the texture the higher the reading before start of irrigation.  
**SANDY SOILS:** Too dry. Hot windy conditions can force soil suction to high reading quickly and damage plants.

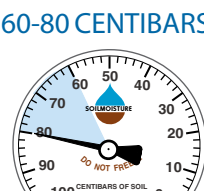

**60-80 CENTIBARS:** Readily available moisture scarce, except in heavy clay soils.  
**HEAVY CLAY SOILS:** Start of irrigation desirable as soil suction values reach 70-80 cb.  
**MEDIUM TEXTURED SOILS:** Too dry. Hot, windy conditions can force soil suction to high reading quickly and damage plants.  
**SANDY SOILS:** Too dry. Damage to plants will occur before irrigation can be applied.

## IRRIGATION TIMING

**IS INFLUENCED BY A NUMBER OF FACTORS IN ADDITION TO THE JET FILL TENSIO METER READING.**

In cooler, moisture climates, irrigation can be somewhat delayed beyond normal without damage to the plant.



In hot dry climates where evapotranspiration is high, and there could be a time lag in applying water, the irrigation cycle should be started early.

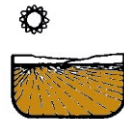

In heavy textured soils, irrigations can be started later because water is depleted more slowly.

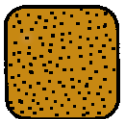

In sandy soils which dry out quickly because of their limited storage capacity, it is critical to closely watch Jet Fill readings and start irrigation on time.

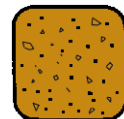

Practical consideration concerning the length of time it takes to complete an irrigation cycle with your system will determine when to start the cycle—so that soil suction values will not get too high before the irrigation water reaches the root zone.



## PLOTTING THE JET FILL TENSIO METER READINGS

Gives you the full picture you need to project when irrigation will be required, taking into account the varying effects of soil type, rainfall, and climate.

The charts below show typical changes in Jet Fill tensiometer readings plotted on our chart form.

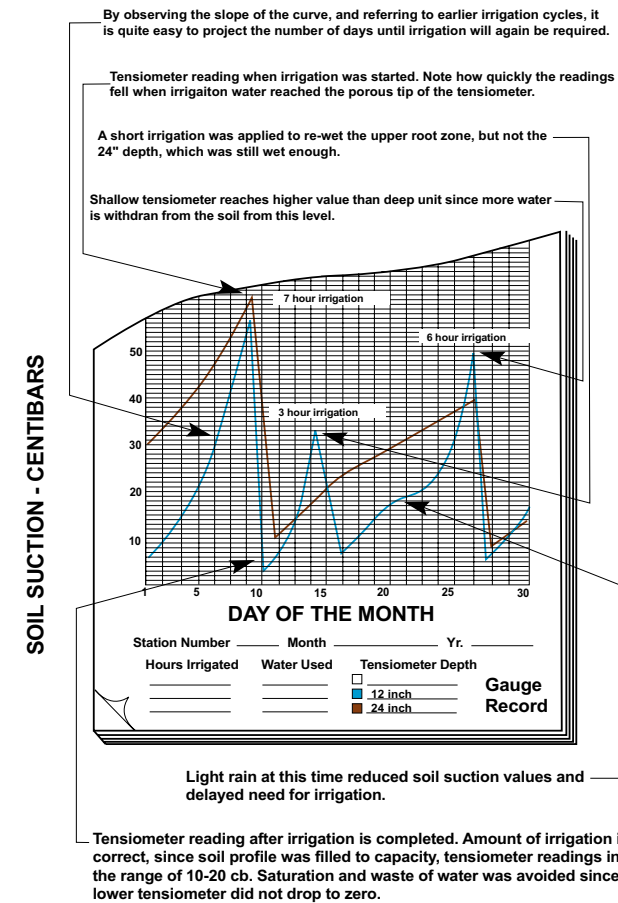

The chart below, covering a 10 month period, records the soil suction value at two levels in a Valencia orange orchard in southern California. Rainfall during the first part of the year, including March and April made irrigation unnecessary. Irrigation on approximately 3 week cycles was neces-

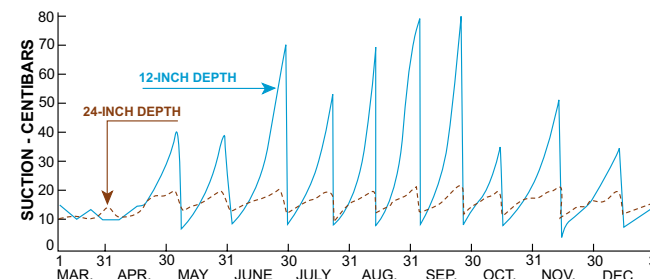

sary to maintain proper moisture. It is evident that irrigation water was not wasted because at no time did the soil in the lower root zone reach the saturation level, zero centibars. This also means that fertilizer was not carried beyond the root zone and would have been fully

## IN AGRONOMY RESEARCH



utilized by the plants. JET FILL TENSIO METERS ARE ESSENTIAL Growing plants involved in research projects require the same careful evaluation of moisture conditions that Jet Fill Tensiometers provide for commercial agriculture. Additionally, research requires the ultimate in accuracy and consistency of measurement. Only the Jet Fill Tensiometer with its unequalled superporous ceramic tip and the unique Jet Fill mechanism to easily and quickly remove air, can provide the sensitivity of response that you need.



The Model 2725AR Series Jet Fill Tensiometer with the optional recalibrator-style vacuum gauge allows accurate setting of the zero position—also adjustment of the pointer to set the water table reference point at the center line of the sensing tip or at the soil surface, required for accurate research data.

The Jet Fill Tensiometer is an excellent diagnostic tool providing pinpoint accuracy of measurement when investigating unusual moisture conditions.

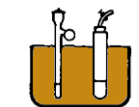

If you are involved with nutrients in the soil, the Jet Fill Tensiometer can be used to indicate when soil suction values are suitable for extraction of soil water samples with suction lysimeters for chemical analysis. As experiments are completed the jet Fill Tensiometers can be easily moved to new test plots.

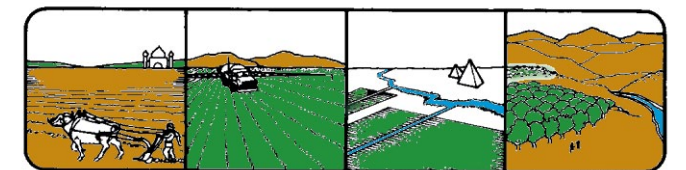

No matter whether your research involves the development of new plant varieties resistant to environmental factors or diseases; the investigation of moisture stress in plants relating to crop production; nutrient studies, or any number of other soil-plant relationships, your use of Jet Fill Tensiometers, that are in general use throughout the world, will insure accurate soil moisture parameters comparable to those of your colleagues in other countries.



## IN HYDROLOGY

### JET FILL TENSIOMETERS FIND MANY APPLICATIONS

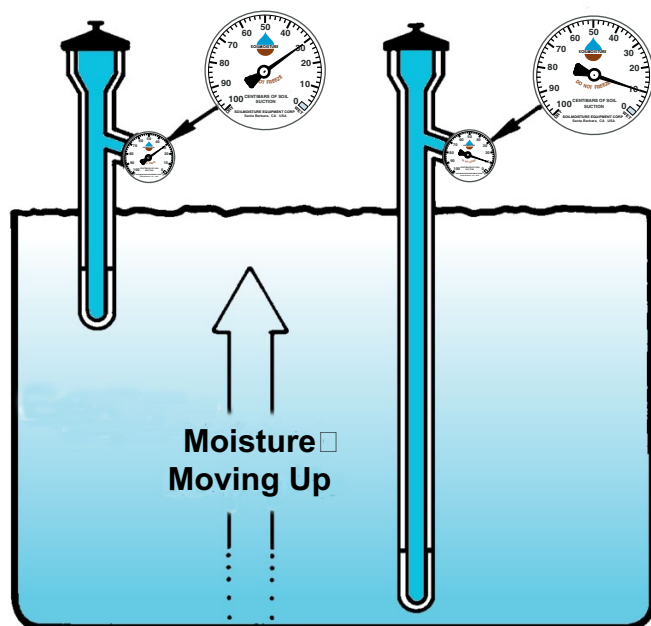

In the vadose zone, the unsaturated zone between soil surface and the ground water, the soil suction in different areas determines the direction in which unsaturated flow of water will take place. Water held at low soil suction values in the soil will move to adjacent areas which have a higher soil suction value. This movement can be in any direction

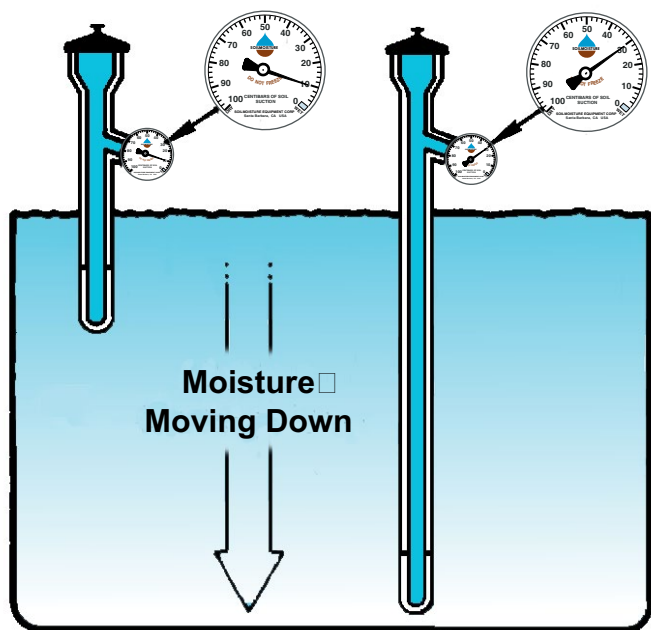

depending upon the relative soil suction values. Jet Fill Tensiometers provide a simple tool to reveal underground flow patterns.

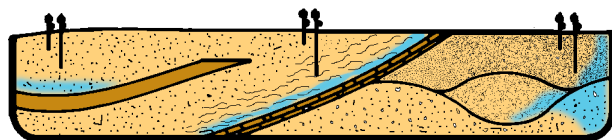

They can reveal the presence of perched water tables, aquifers, and unusual moisture conditions near changing strata in the soil profile. They can reveal the presence of subsurface seepage below water or waste storage areas. Jet Fill Tensiometers provide a means of verifying proper moisture conditions for sampling of the soil solution through the use of vacuum lysimeters.

### JET FILL TENSIOMETERS QUICKLY PAY FOR THEMSELVES

#### PROFITS AND SAVINGS COME FROM MANY SOURCES



**Water** is becoming a scarce commodity in many parts of the world, and crop irrigation is one of the largest water uses. Jet Fill Tensiometers assure that you are applying a minimum amount of water—conserving water and lowering your water use costs.



**Energy costs** have skyrocketed as basic fuels have become scarce and demand has overtaken supply. Jet Fill Tensiometers allow you to reduce expensive energy-consuming pumping costs as you reduce your water requirements.



**Fertilizer** is a large cost factor in the growing of a crop. Whether applied through the irrigation water or by surface application, Jet Fill Tensiometers allow you to save expensive fertilizer by providing precise information to limit percolation of water and dissolved fertilizer only to the root zone—avoiding over irrigation that carries fertilizer beyond the root zone and wasting it.



**Labor** is an expensive part of each irrigation cycle. By indicating moisture conditions accurately, Jet Fill Tensiometers frequently make it possible to reduce the number of irrigation cycles for the production of a crop, saving all the associated labor.

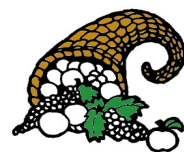

**Crop Yield:** By making it possible to regulate moisture conditions to ideal levels during crop production, Jet Fill tensiometers make it possible to realize substantially increased crop yields per acre.

### ORDER COMPLETE SOILMOISTURE TENSIOMETERS BY MODEL NUMBER



#### MODEL 2710AR SERIES

An inexpensive, versatile tensiometer supplied with solid sealing cap and recalibrator-type vacuum gauge. Ideal for general irrigation control purposes.

#### Stock sizes available:

2710ARL06	Soilmoisture Tensiometer, 6-inch size
2710ARL12	Soilmoisture Tensiometer, 12-inch size
2710ARL18	Soilmoisture Tensiometer, 18-inch size
2710ARL24	Soilmoisture Tensiometer, 24-inch size
2710ARL36	Soilmoisture Tensiometer, 36-inch size
2710ARL48	Soilmoisture Tensiometer, 48-inch size
2710ARL60	Soilmoisture Tensiometer, 60-inch size



#### MODEL 2725AR SERIES

Ideal for research purposes and irrigation control. Provided with Jet Fill Reservoir Cap and recalibrator-type gauge.

#### Stock sizes available:

2725ARL06	Jet Fill Tensiometer, 6-inch size
2725ARL12	Jet Fill Tensiometer, 12-inch size
2725ARL18	Jet Fill Tensiometer, 18-inch size
2725ARL24	Jet Fill Tensiometer, 24-inch size
2725ARL36	Jet Fill Tensiometer, 36-inch size
2725ARL48	Jet Fill Tensiometer, 48-inch size
2725ARL60	Jet Fill Tensiometer, 60-inch size

#### Select a Tensiometer to Fit your Application

The unique, modular construction of Soilmoisture Tensiometers allows you to configure a tensiometer exactly suited to your research, management or monitoring application. Start by selecting the appropriate Tensiometer Body and Cup. For each tensiometer station you can then select an appropriate Top Seal Option and Measurement Option from the list below. Further flexibility in application is provided by the Tensiometer Extension Tube Option. The length of a tensiometer can be extended, or an angled extension can be used for pinpoint placement of the ceramic cup.

#### Stock sizes available:

2630AL06	Tensiometer Body and Cup, 6-inch size
2630AL12	Tensiometer Body and Cup, 12-inch size
2630AL18	Tensiometer Body and Cup, 18-inch size
2630AL24	Tensiometer Body and Cup, 24-inch size
2630AL36	Tensiometer Body and Cup, 36-inch size
2630AL48	Tensiometer Body and Cup, 48-inch size
2630AL60	Tensiometer Body and Cup, 60-inch size

#### TOP SEAL OPTIONS

2079	SCREW CAP Provides vacuum tight seal
2075	JET FILL RESERVOIR CAP, COMPLETE Reservoir provides vacuum tight seal, push button servicing convenience, and no soil disturbance when replenishing water to tensiometers.

#### TENSIOMETER MEASUREMENT OPTIONS

(All with 1/4 NPT stem fittings for use with Soilmoisture Tensiometers)

2060FG3	VACUUM DIAL GAUGE 2-inch dial, 0-100 centibar scale
5301	CURRENT TRANSDUCER 4-20 ma output, fully temperature compensated and hermetically sealed for rugged field use.

#### TENSIOMETER EXTENSION TUBE OPTIONS

Stock sizes available:

2720L06	Extension tube, 6-inch size
2720L12	Extension tube, 12-inch size
2720L24	Extension tube, 24-inch size
2720L60	Extension tube, 60-inch size
2721A135	Extension tube, 12-inch size with 135 degree angle

#### ACCESSORY ITEMS 2710K1 SERVICE KIT

Kit should be ordered with each initial order of tensiometers



#### 0240L INSERTION TOOL

Cuts 7/8" diameter hole in rock-free soils for rapid installation of 2725 and 2710 Series Tensiometers.

#### 230D2 SOIL AUGER, 2-INCH DIAMETER

5-foot overall length for installation of tensiometers in rocky soils.

2040G100	MONTHLY CHART FORMS (pad of 100)
2041	TENSIOMETER CHART (12 months)

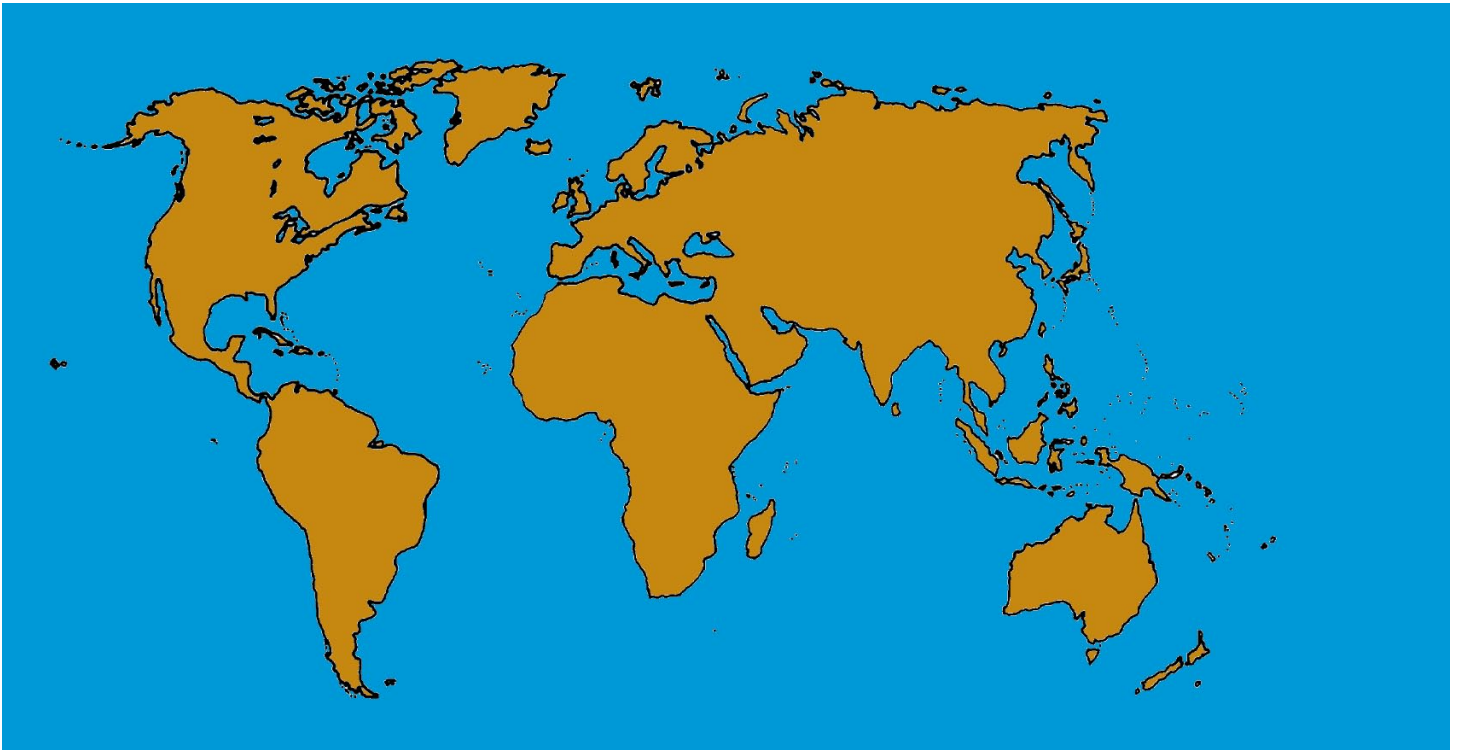

### **FOR FURTHER INFORMATION AND TO PLACE ORDERS**

Soilmoisture Equipment Corp.  
P.O. Box 30025  
Santa Barbara, CA 93105 USA

Telephone: 805-964-3525  
Fax: 805-683-2189  
Email: [sales@soilmoisture.com](mailto:sales@soilmoisture.com)  
Website: <http://www.soilmoisture.com>

Plant and office location:  
801 S. Kellogg Avenue  
Goleta, California 93117 USA

